

CeMend™ Shoulder Spacer Molds

Surgical Technique

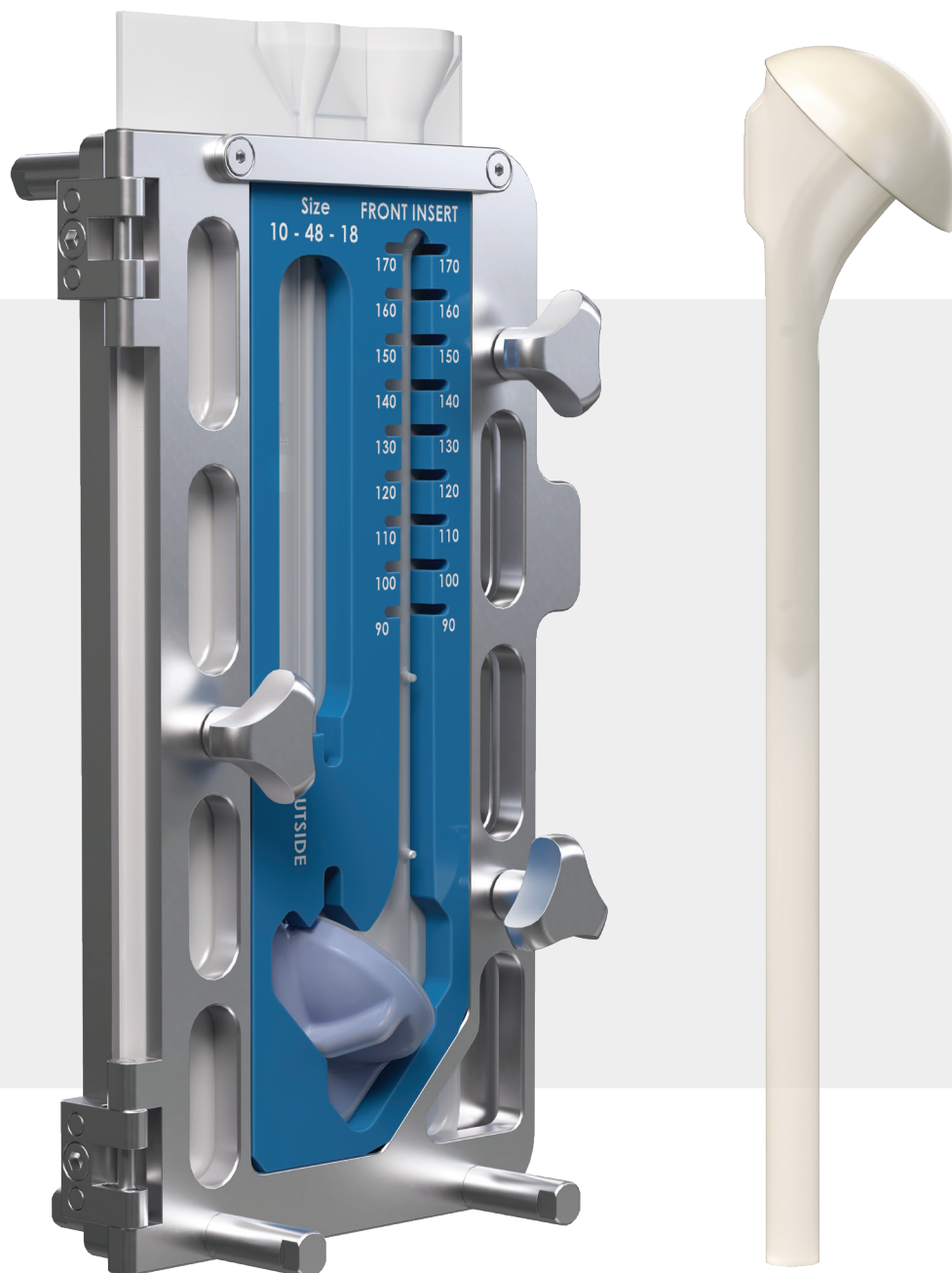

CeMend™ Shoulder Spacer Molds

The [CeMend shoulder spacer mold](#) device consists of two plastic half molds and a stainless-steel stem with two centering pins made of polymethylmethacrylate bone cement.

The [CeMend shoulder spacer mold](#), once assembled with the aid of the [CeMend shoulder mold set](#) accessory, allows the creation of a cavity specifically designed to allow the injection of low viscosity polymethylmethacrylate bone cement to obtain a temporary shoulder spacer.

Caution: Federal law (USA) restricts this device to sale by or on the order of a physician.

Indications for Use

CeMend Shoulder Spacer Mold

Disposable cement spacer molds with metal reinforcement stem are indicated for use to mold a temporary hemi-shoulder replacement for skeletally mature patients undergoing a two-stage revision procedure due to a septic process.

The temporary spacer is molded using medium viscosity polymethylmethacrylate bone cement and inserted into the humeral medullary canal and glenoid cavity of the shoulder following removal of the existing humeral and glenoideal cavity implants and debridement. The [CeMend shoulder spacer mold](#) should only be used with [Arthrex Bone Cement MV+G](#).

The device is intended for use in conjunction with systemic antimicrobial antibiotic therapy (standard treatment approach to an infection).

The hemi-shoulder spacer made from the [CeMend shoulder spacer mold](#) disposable cement molds is not intended for use more than 180 days, at which time it must be explanted and permanent devices implanted or another appropriate treatment performed (eg, resection arthroplasty, fusion, etc).

Due to the inherent mechanical limitations of the hemi-shoulder spacer material (medium viscosity polymethylmethacrylate), the temporary hemi-shoulder spacer is only indicated for patients who will consistently follow activity limitation throughout the implant period.

The device can exclusively be used by competent healthcare personnel who has complete scientific and anatomical knowledge.

For what concerns the modes of usage of the bone cement potentially loaded with antibiotics, see the instructions for use of the selected bone cement.

Arthrex Bone Cement

The [Arthrex Bone Cement HV](#) and [Arthrex Bone Cement MV](#) radiopaque bone cements are intended for use in arthroplasty procedures of the hip, knee, ankle, shoulder and other joints for the fixation of polymer or metallic prosthetic implants to living bone.

The [Arthrex Bone Cement HV+G](#) and [Arthrex Bone Cement MV+G](#) bone cements are indicated for use in the second stage of a two-stage revision for total joint arthroplasty after the initial infection has been cleared. Arthrex Bone Cement MV+G shall not be used for any use other than the specified intended use.

Note: The CeMend Shoulder Spacer Mold is cleared for use with Arthrex Bone Cement MV+G.

Spacer Dimensions

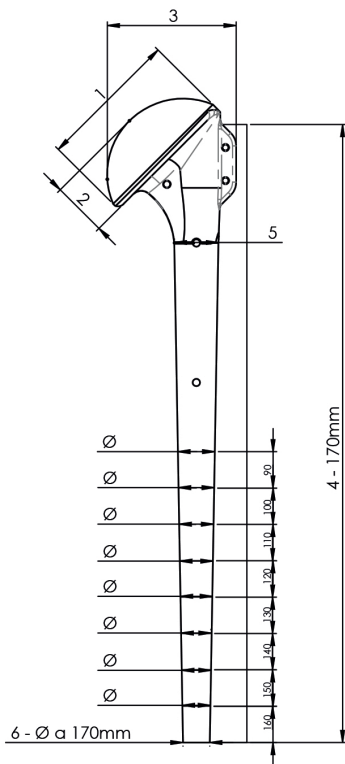

Description	Stem Length (mm)	3						
		1	2	42-15	48-18	4	5	6
Head 42-15		38.1	14.5					
Head 48-18		44.1	17.5					
Stem 8 mm	90			34.9		89.3	8	6.8
Stem 10 mm	90			34.9	39.7	89.3	10	8.5
	100		98.9			8.4		
	110		109.3			8.2		
	120		119.9			8		
	130		129.7			7.9		
	140		140			7.6		
	150		149.7			7.5		
	160		160			7.4		
Stem 12 mm	90			34.9	39.7	89.3	12	9.6
	100		98.9			9.2		
	110		109.3			8.9		
	120		119.9			8.5		
	130		129.7			8.2		
	140		140			7.8		
	150		149.7			7.5		
	160		160			7.3		
Stem 14 mm	90				39.7	89.3	14	11.7
	100		98.9			11.4		
	110		109.3			11		
	120		119.9			10.7		
	130		129.7			10.4		
	140		140			10.1		
	150		149.7			9.8		
	160		160			9.5		
	170		169.8	9.2				

Spacer Configurations

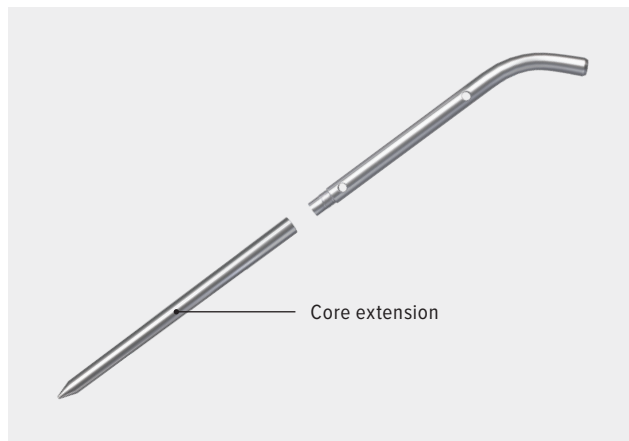
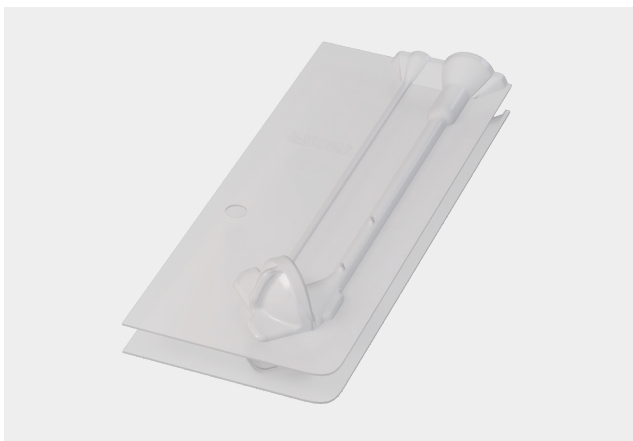

Disposable Mold for Spacer Realization

Six molds are provided, distinguished by the combination of stem and head-offset:

- Stem Ø: 8 mm, head-offset: 42-15
- Stem Ø: 10 mm, head-offset: 42-15
- Stem Ø: 10 mm, head-offset: 48-18
- Stem Ø: 12 mm, head-offset: 42-15
- Stem Ø: 12 mm, head-offset: 48-18
- Stem Ø: 14 mm, head-offset: 48-18

Two metal core extensions can be purchased separately. Use the short extension to prepare spacers with a stem length between 135 mm and 160 mm. Use the longer extension when a 170 mm stem is needed. The core extensions provide a higher distal resistance but their use is not mandatory.

Spacer Mold Preparation

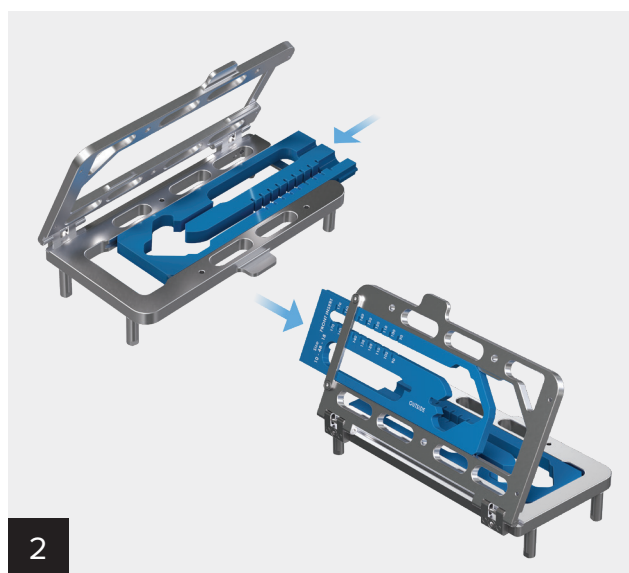

1 Select the appropriate-size press and head form that corresponds with the selected mold.

2 Slide the insert into the base.



Slightly peel back the mold to position the head insert. Attach the optional stem extension if desired.

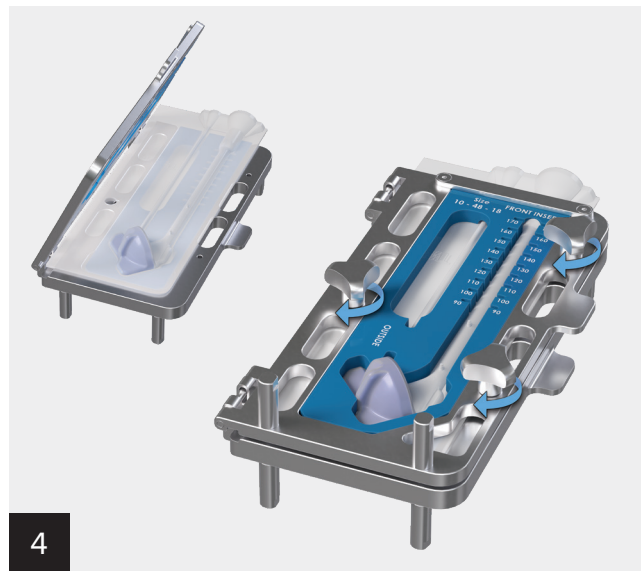

Ensure proper alignment of the mold in the base. Press and screw the base closed tightly.

Cement Configurations

Arthrex Bone Cement is available in 4 options including high viscosity (HV) and medium viscosity (MV), both with and without gentamicin (G). It is recommended to use Arthrex MV+G cement when creating spacer molds. MV cement should be utilized for mold creation or anytime the syringe mixing device is preferred. HV cement creates more doughy handling characteristics.

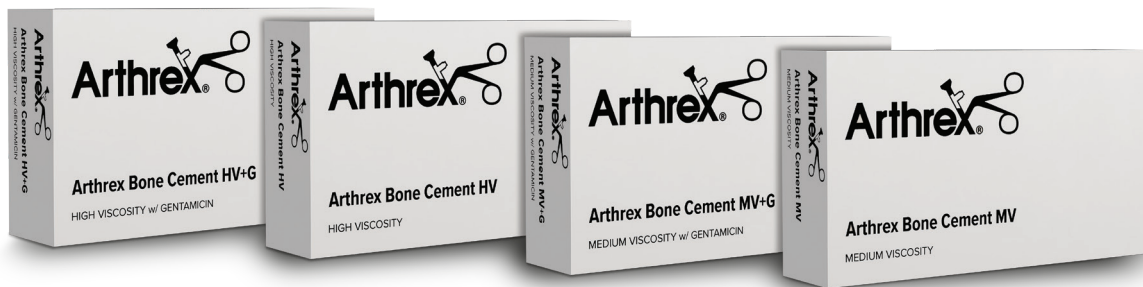

Cement Working Times

Bone cement characteristics are critical to understand and are dramatically affected by a number of factors. Specific factors include, but are not limited to, ambient room temperature, humidity, and mixing methods.

Note: Handling characteristics and setting time of bone cements are affected by temperature, humidity, and mixing methods.

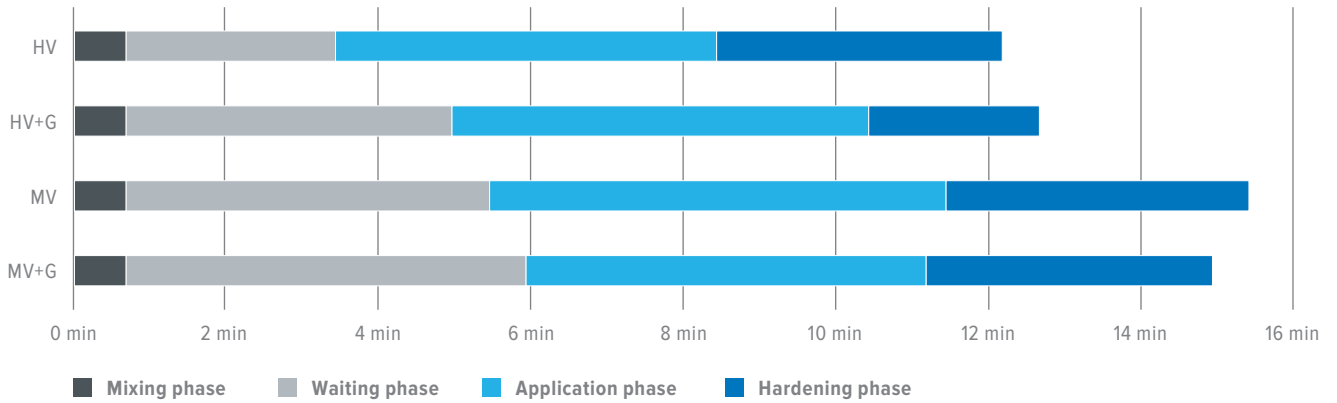

Note: All times presented are for cement mixed without vacuum.

Without Gentamicin

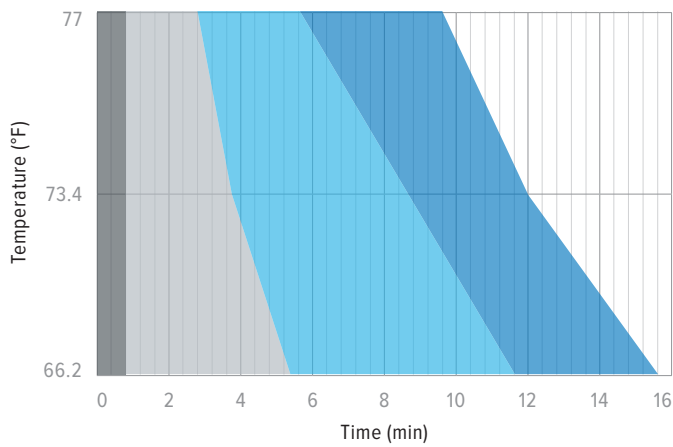

With Gentamicin

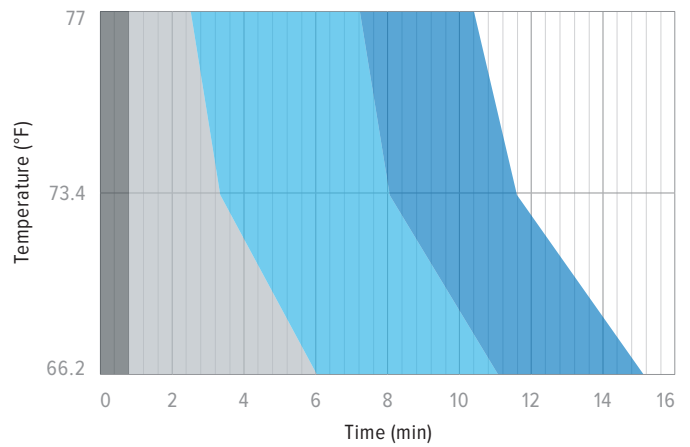

Medium Viscosity

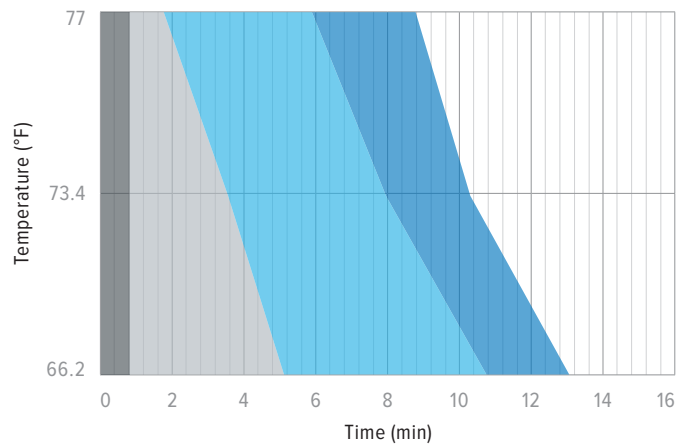
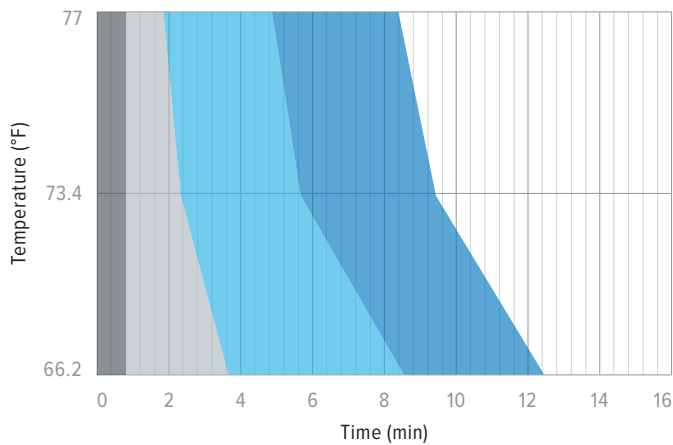

High Viscosity

Mechanical Properties

Arthrex Bone Cement exceeds all requirements set by ISO 5833:2002.

Bending Modulus

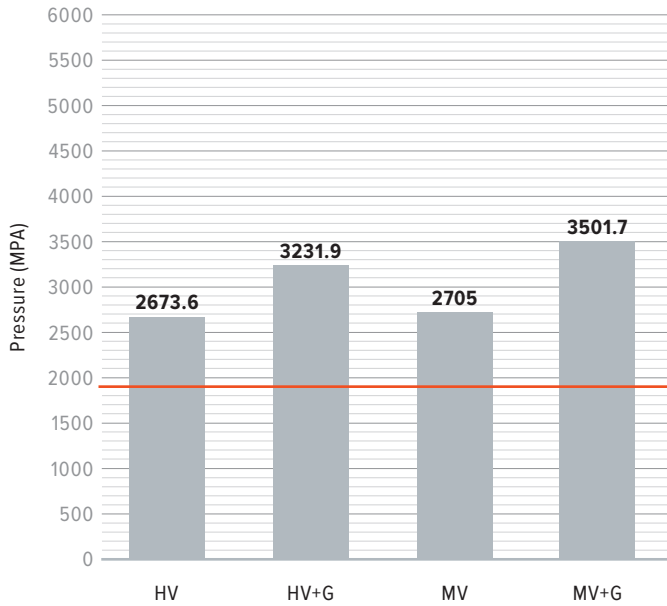

Bending Strength

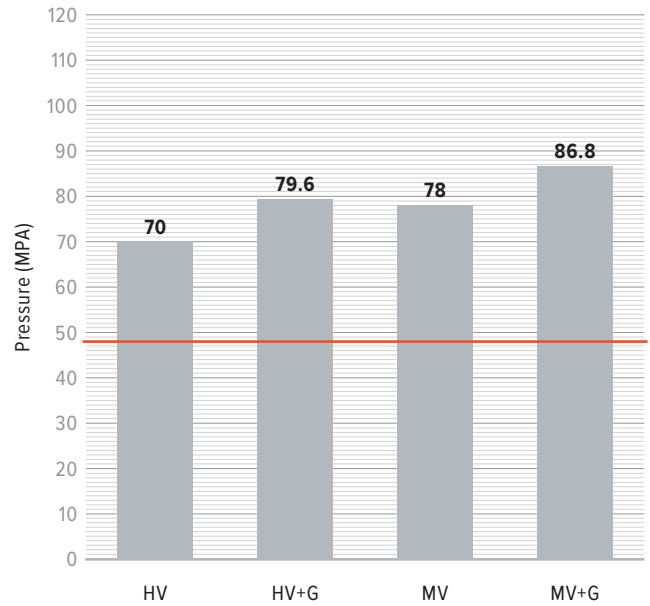

Compressive Strength

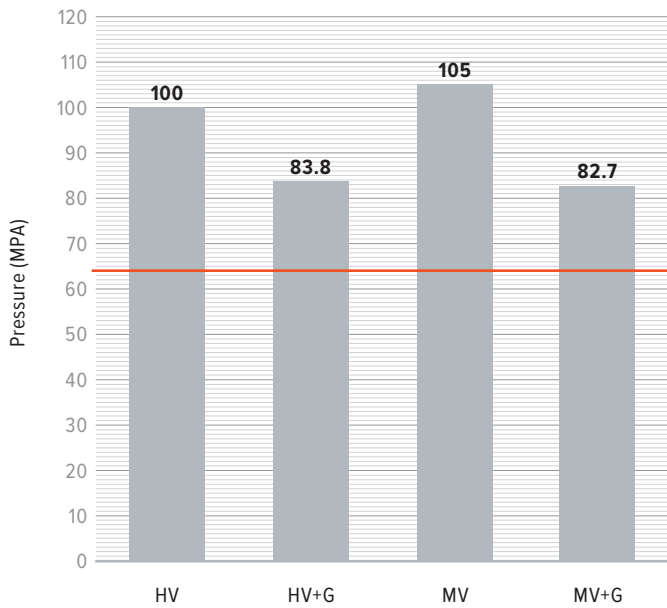

Maximum Temperature

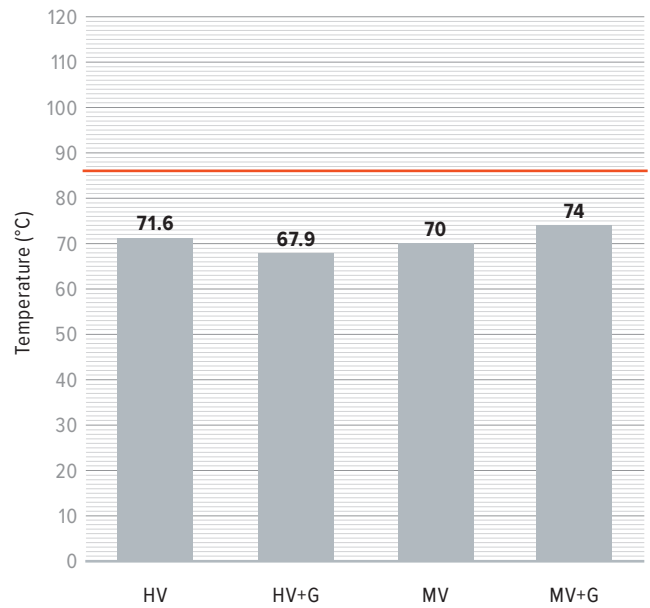

— ISO 5833 Standard

Cement Preparation

Two batches of cement are needed to create the shoulder spacer.

It is recommended to use Arthrex Bone Cement MV or MV+G with syringe mixer to create the spacer molds.

Notes:

- To improve elution characteristics, mixing under vacuum pressure is not recommended.
- Arthrex Bone Cement is manufactured by G21 SrL. Arthrex Bone Cement MV and MV+G options are equivalent to the manufacturer's G3 low-viscosity offering.



Pull the plunger up completely and remove the cap.

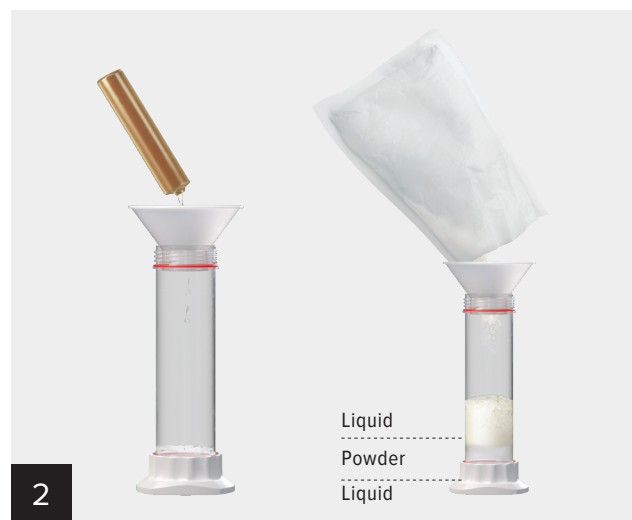

To ensure appropriate mixing when using the syringe, the first liquid monomer should be added to the apparatus first and the second should be added last, leaving the powder polymer in the middle of the solution.

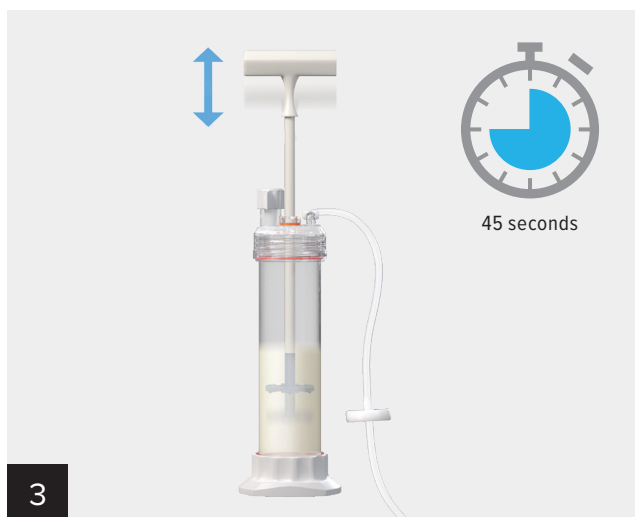

Mix thoroughly for 45 seconds.

Note: To improve elution characteristics, mixing under vacuum pressure is not recommended.



Pull the plunger up completely so that a blue line is visible, and snap off the plunger rod. Attach the nozzle and trim as desired based on the mold size.

Data on file with manufacturer (G21 SrL).

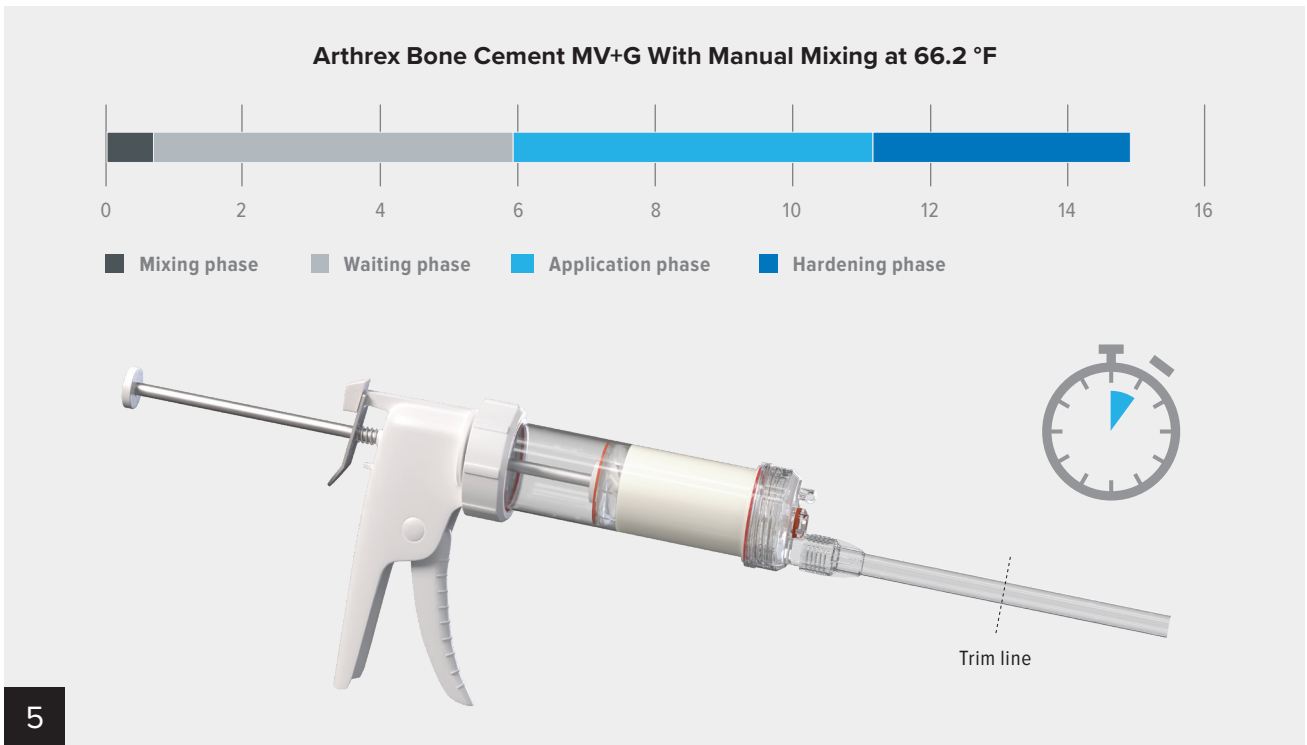

Wait for the cement to be approximately the consistency of white glue prior to injecting it into the mold. This should be near the beginning of the **application phase**.

Note: If using an 8 mm stem, leave the nozzle full length. If a 10 mm, 12 mm, or 14 mm stem is used, trim the nozzle approximately in half. Prime the nozzle gently to remove space from the back of the syringe.

Prior to use, refer to the bone cement's and mold's directions for use for a full list of warnings, instructions, and contraindications.

Creation of the Shoulder Spacer

Two batches of cement are needed to create the shoulder spacer.

Insert the nozzle fully into the mold, then slowly and consistently inject the cement into the mold until full.

Leave the mold upright until fully hardened.



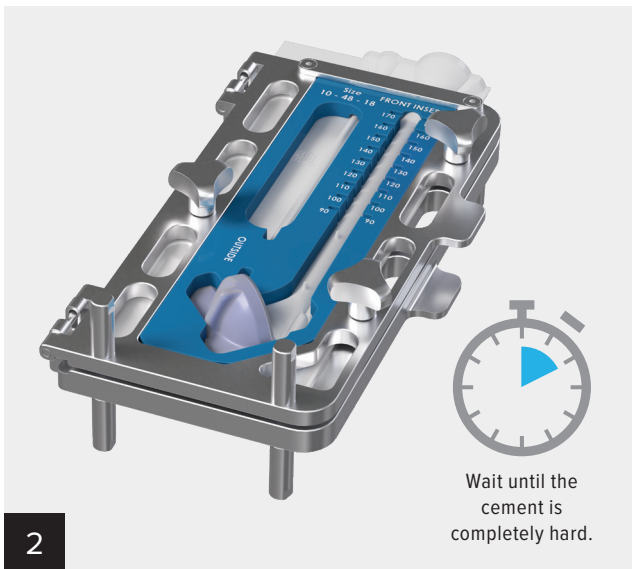

2

Wait until the cement is completely hard.

Use an osteotome to score the stem at the desired length.



3

Disassemble the screws and open the base to remove the mold. Manually remove the cement spacer from the mold and use the included pilars and a twisting motion to remove the head form. If necessary, break the stem at the scored mark to ensure proper length.

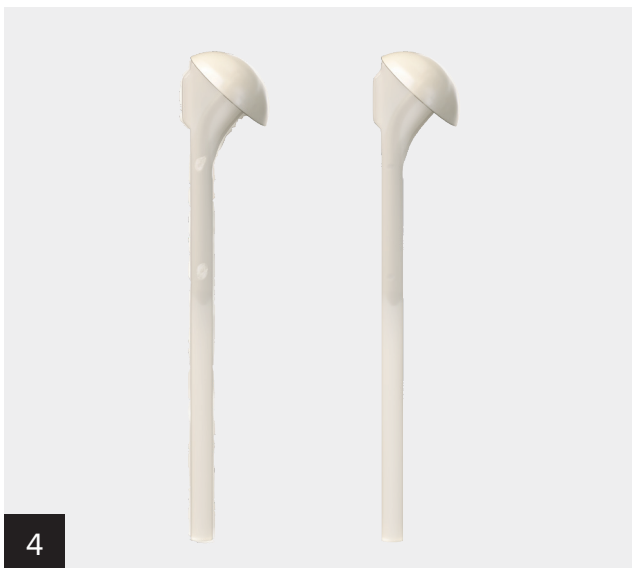

4

Use the pliers and rasp provided to remove all of the flashing produced by the mold.

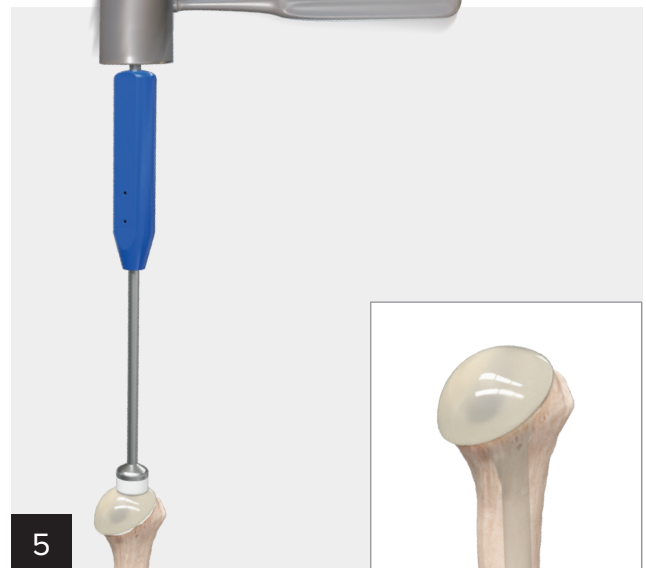

5

Implantation can be performed with cement for fixation (keep in mind surgical considerations such as explantation when choosing amount of cement and level of spacer fixation).

Ordering Information

Product description	Item number
Arthrex Bone Cement HV	AR-901-HV
Arthrex Bone Cement HV+G	AR-901-HVG
Arthrex Bone Cement MV	AR-901-MV
Arthrex Bone Cement MV+G	AR-901-MVG
Arthrex Bone Cement Open Mixing Bowl	AR-901-1
Arthrex Bone Cement Closed Mixing Bowl	AR-901-2
Arthrex Bone Cement Mixing Syringe	AR-901-3
Arthrex Bone Cement Syringe Gun, disposable	AR-901-4
CeMend Shoulder Spacer Mold 8-42	AR-902-0842M
CeMend Shoulder Spacer Mold 10-42	AR-902-1042M
CeMend Shoulder Spacer Mold 10-48	AR-902-1048M
CeMend Shoulder Spacer Mold 12-42	AR-902-1242M
CeMend Shoulder Spacer Mold 12-48	AR-902-1248M
CeMend Shoulder Spacer Mold 14-48	AR-902-1448M
CeMend Core Extension	AR-902-EXT

CeMend™ Spacer Mold Set (AR-902-S)

Product description	Item number
CeMend Mold Base	AR-902-01
CeMend 8-42 Mold Insert Press	AR-902-02
CeMend 10-42 Mold Insert Press	AR-902-03
CeMend 10-48 Mold Insert Press	AR-902-04
CeMend 12-42 Mold Insert Press	AR-902-05
CeMend 12-48 Mold Insert Press	AR-902-06
CeMend 14-48 Mold Insert Press	AR-902-07
CeMend Base Compression Bolt	AR-902-08
CeMend 42 mm Head Insert	AR-902-09
CeMend 48 mm Head Insert	AR-902-10
Rasp	AR-902-11
Pliers	AR-902-12



This description of technique is provided as an educational tool and clinical aid to assist properly licensed medical professionals in the usage of specific Arthrex products. As part of this professional usage, the medical professional must use their professional judgment in making any final determinations in product usage and technique. In doing so, the medical professional should rely on their own training and experience, and should conduct a thorough review of pertinent medical literature and the product's directions for use. Postoperative management is patient-specific and dependent on the treating professional's assessment. Individual results will vary and not all patients will experience the same postoperative activity level or outcomes.

arthrex.com

© 2025-04 Arthrex, Inc. All rights reserved. LT1-000328-en-US_C



Arthrex manufacturer,
authorized representative,
and importer information
(Arthrex eIFUs)



US patent information