

QuadLink™ *Internal/Brace*™ Technique With FiberTag® TightRope® SB Implants

Surgical Technique



FiberTag® TightRope® SB Implant Introduction

The TightRope® SB implant is the ultimate innovation in adjustable cortical suspensory fixation technology. Using a radiopaque, all-suture cortical button, this implant is stronger¹ with a minimally invasive, low-profile design compatible with existing RetroConstruction™ and TightRope drill pin socket creation techniques. The flat-tape TightRope loop improves graft interface and handling characteristics during graft tensioning and provides greater resistance to graft abrasion.² Additionally, the TightRope SB implant features a shorter minimum loop length to maximize the amount of graft in the socket.

FEATURES AND BENEFITS

- › **All-suture button design:** Revolutionary all-suture, soft-button technology to eliminate metal from ACL reconstruction **(a)**
- › **Ability to reflip:** Implant can be reflipped as needed; radiopaque design allows for button-flipping confirmation
- › **InternalBrace™ technique:** Available with preloaded radiolucent or radiopaque FiberTape® suture for the *InternalBrace* technique **(b)**, proven in peer-reviewed published studies to be associated with lower ACL retear rates at 2 and 5 years,³⁻⁶ less pain, improved patient-reported outcomes, and a faster and higher rate of return to preinjury level of activity⁷
- › **Flat-tape TightRope implant:** Offers better handling characteristics and is more resistant to graft abrasion than traditional round sutures¹ **(c)**
- › **Comprehensive options:** Available in RT, BTB, FiberTag®, and repair implant configurations

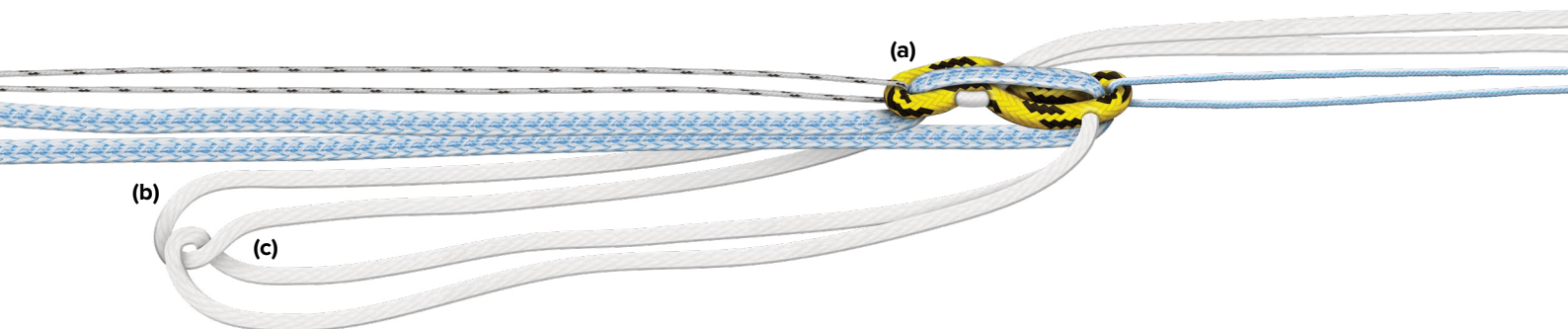
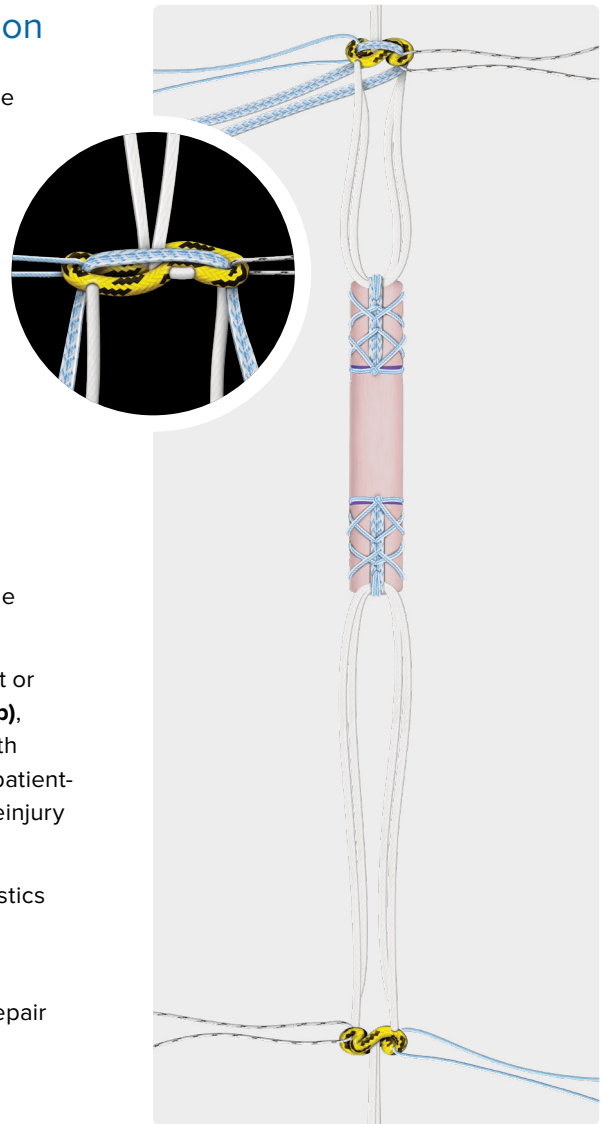

The *InternalBrace* surgical technique is intended only to augment the primary repair/reconstruction by expanding the area of tissue approximation during the healing period and is not intended as a replacement for the native ligament. The *InternalBrace* technique is for use during soft tissue-to-bone fixation procedures and is not cleared for bone-to-bone fixation.

FiberTag® TightRope® SB Surgical Technique



01

Mark the tendon at the desired length of the whipstitch.

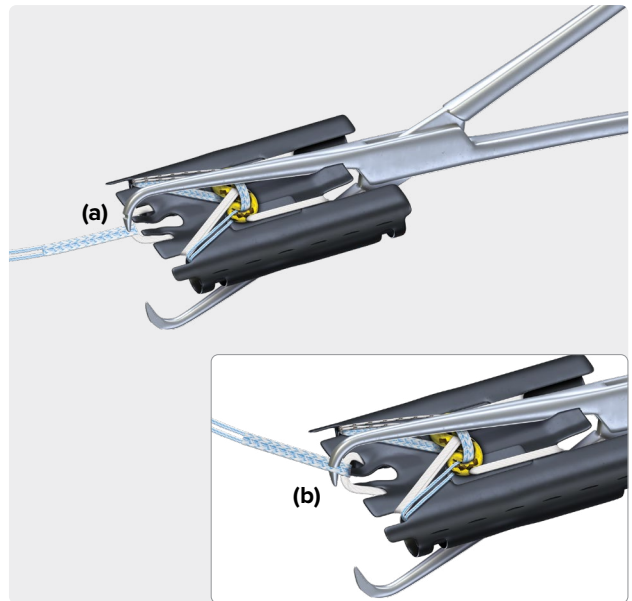

02

Remove the FiberTag TightRope SB implant with FiberTape® suture card from the larger packaging card. Orient the suture card with the FiberTag® suture facing the teeth of the GraftClamp instrument (AR-2386T). Then load the card into the card-holding slot of the instrument **(a)**. Use the top tooth of the GraftClamp instrument to pierce the FiberTag suture **(b)**.

Note: Ensure the TightRope® implant is not pierced by the GraftClamp instrument.

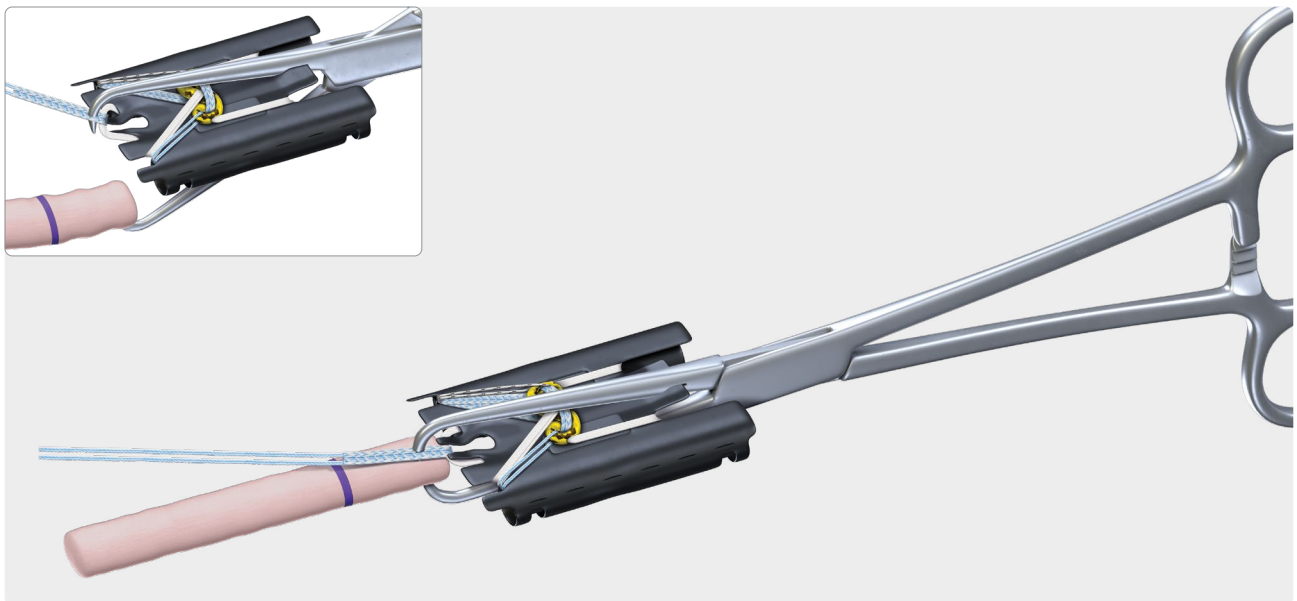

03

Clasp the GraftClamp instrument approximately 2 mm from the end of the graft. Provisionally place the FiberTag suture on the graft to determine appropriate positioning.

04

Use the needle's initial pass through the graft to determine the position of the FiberTag® suture **(a)**. This pass should occur where the FiberTag suture converts to FiberLoop® suture. After the initial pass through the graft, perform the standard SpeedWhip™ rip-stop technique, working toward the suture card and ensuring the FiberTag suture is captured with each needle pass.

Note: After passing the needle through the graft tissue, remove the slack and tension each pass by pulling on the suture rather than the needle.

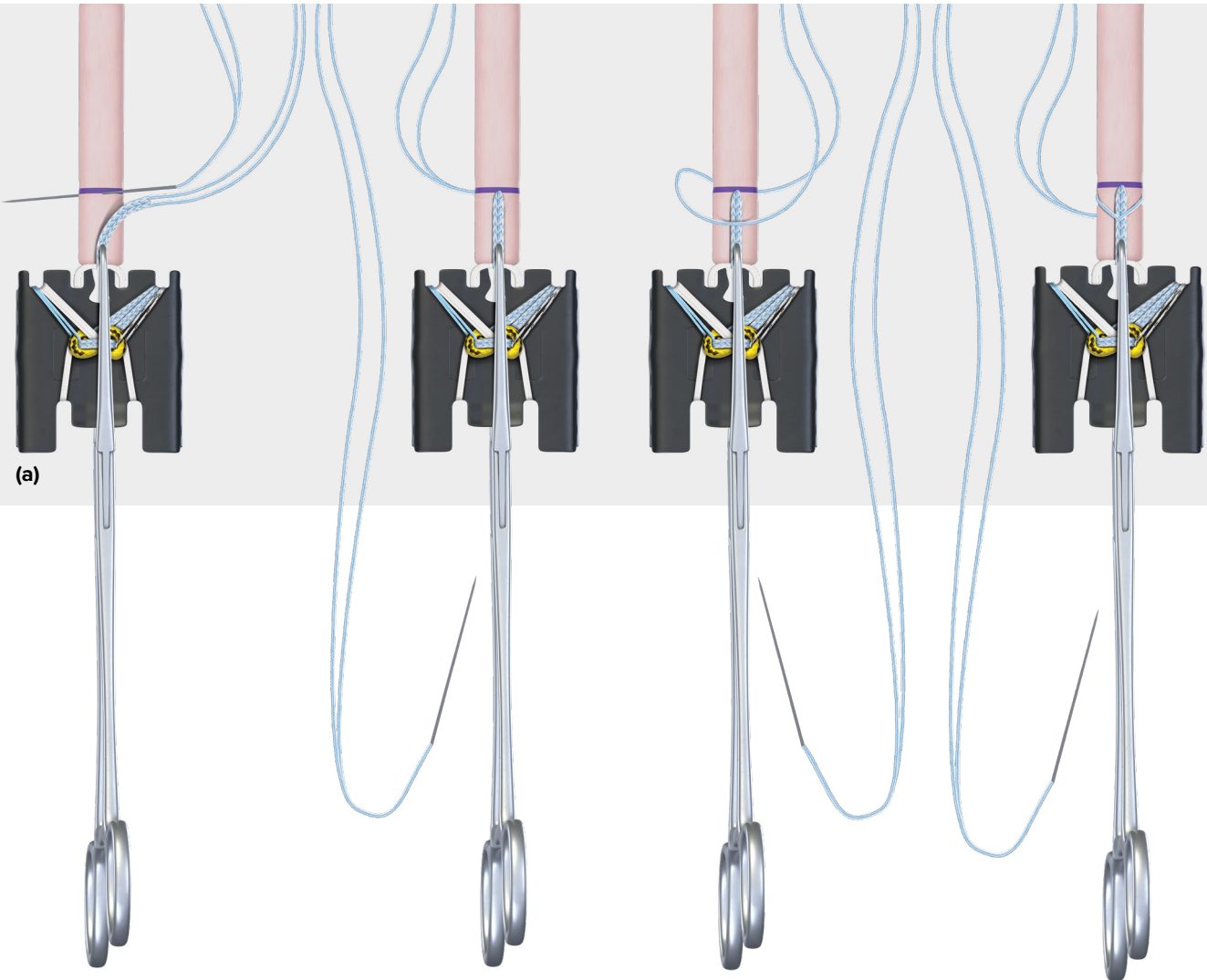

05

After placing 2 SpeedWhip™ stitches in the graft, pass the needle through the slot in the suture card, ensuring the needle passes over the TightRope® implant and through the FiberTag® suture just below the tooth of the GraftClamp (a). Then repeat the SpeedWhip rip-stop technique with 2 additional passes, working away from the GraftClamp instrument and ensuring that the FiberTag suture is captured with each pass (b). Make a final pass at the end of the FiberTag suture (c). Cut 1 limb of suture just below the splice of the needle (d).

| **Note:** View from underside of the graft (a).

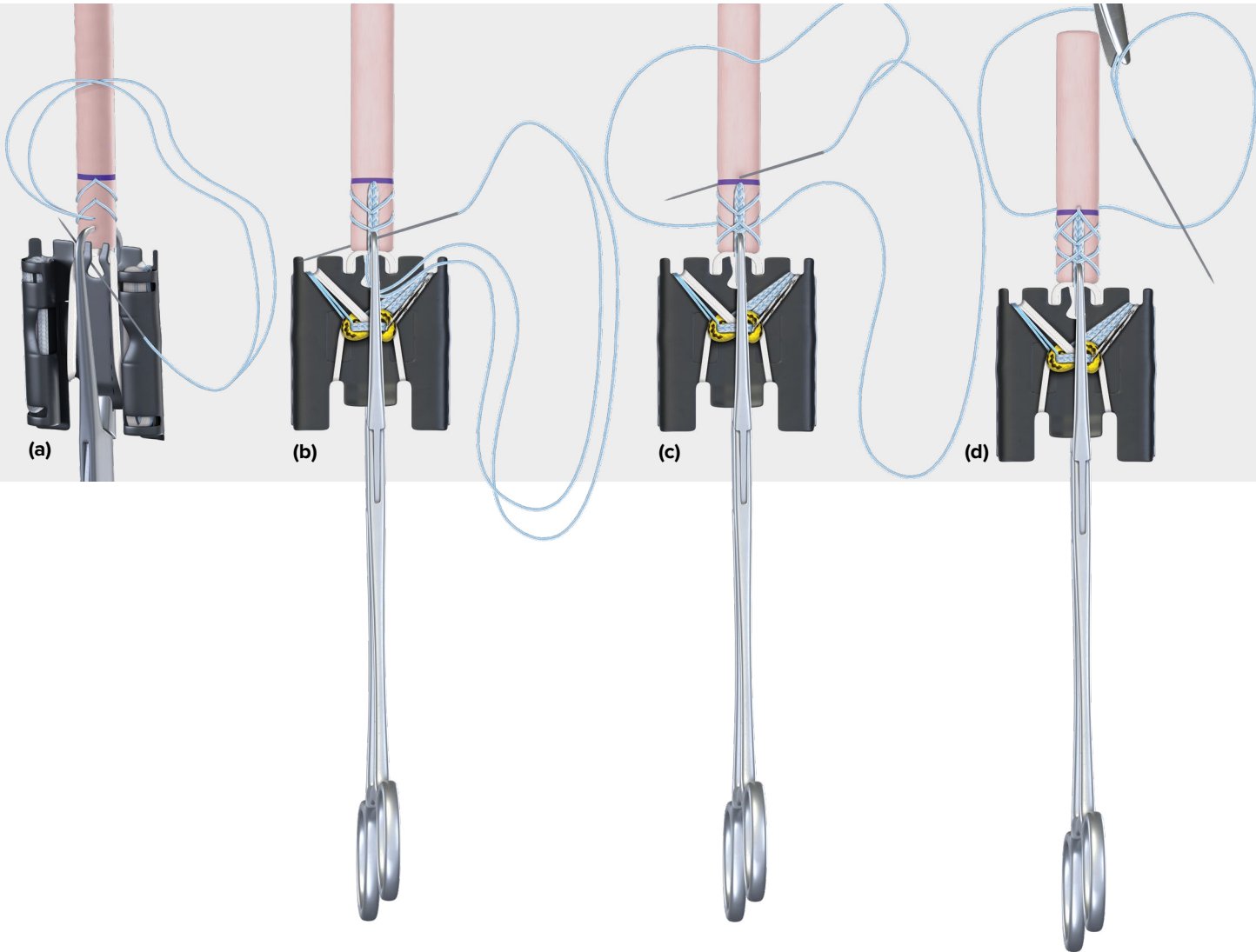

Wrap the suture limbs around the graft and tie the knot to secure the construct. Cut the suture limb without the needle just above the knot **(a)**. Pierce the needle through the tendon on the knot side **(b)**. Pull the needle and suture completely through the graft and apply tension to bury the knot in the graft **(c)**. Cut the suture limb flush to the graft.

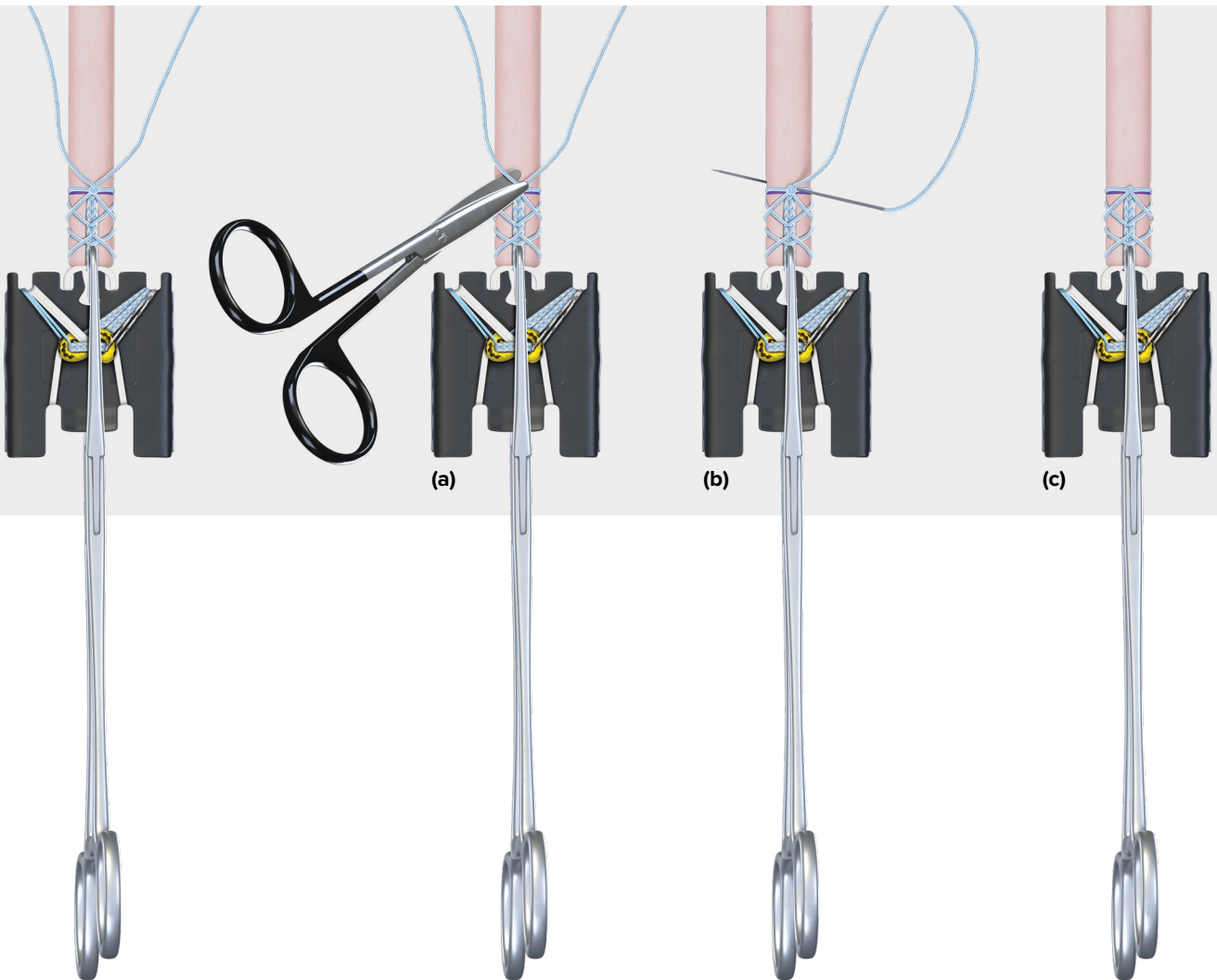

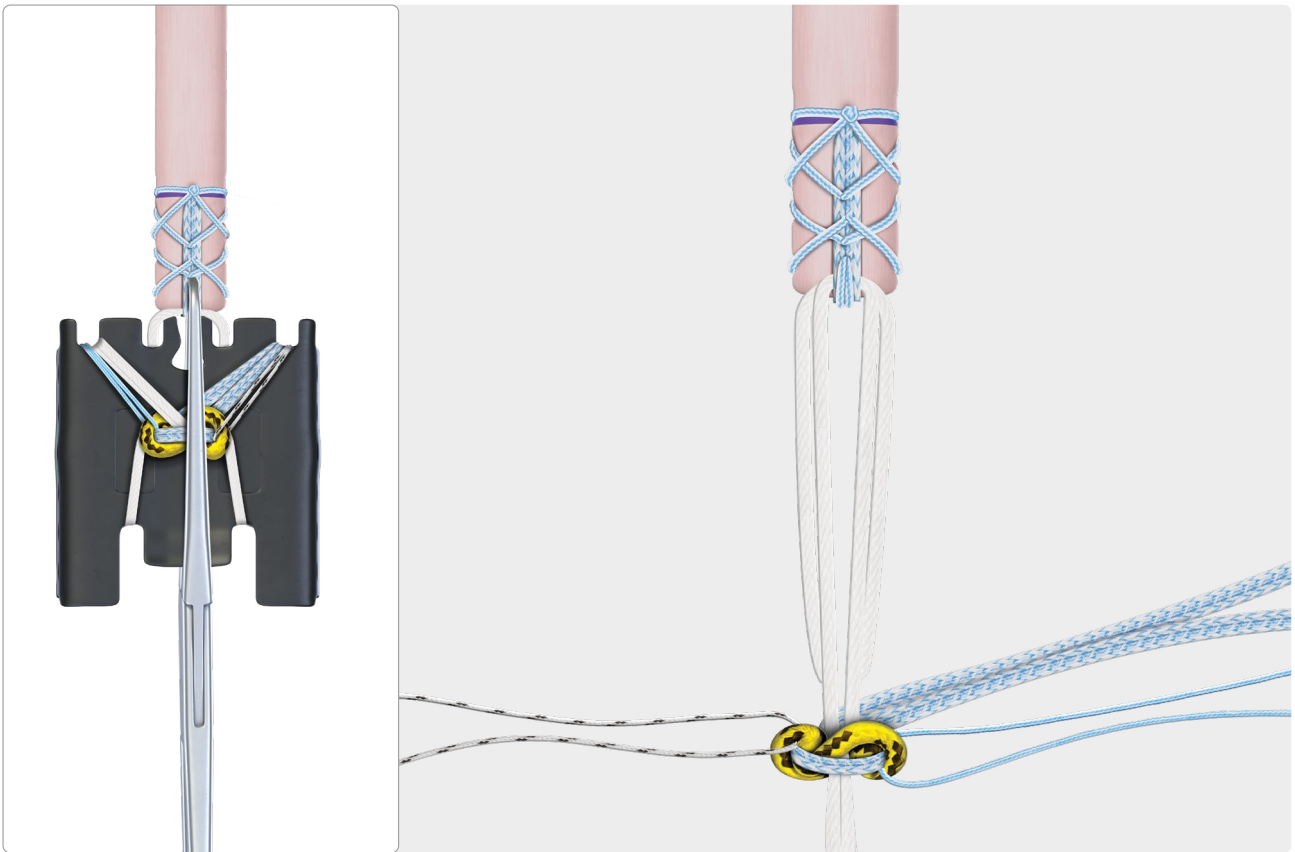

07

Remove the suture card from the GraftClamp instrument. Unwrap the sutures from the suture-card cleat and remove the TightRope® implant loops from the retaining slots in the card. Graft preparation of the femoral side is complete.

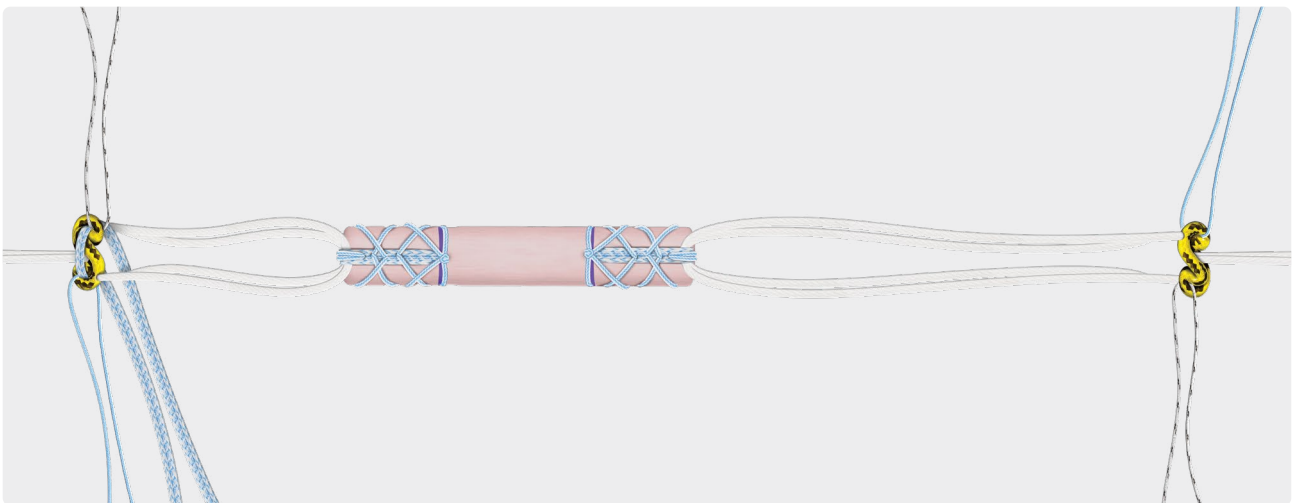

08

The flexible composition of the all-suture button allows for easy passage through the tibial tunnel, eliminating the need for an attachable metal button. Repeat steps 1-7 on the opposite end of the graft with a FiberTag® TightRope® SB implant to complete the final construct.

Socket Creation

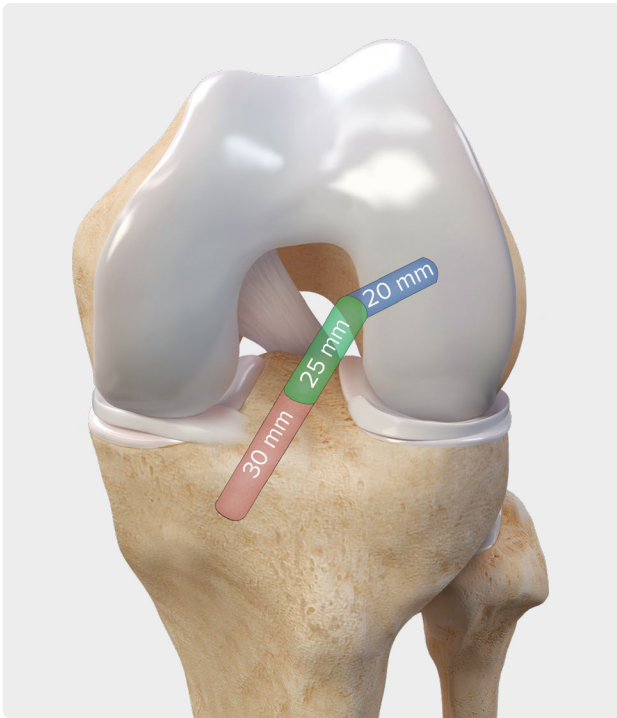

The length from the end of the femoral socket to the end of the tibial socket should be at least 10 mm longer than the graft to ensure that the graft can be tensioned fully.

Assuming an intra-articular length of 25 mm, there will be approximately 20 mm of graft in the femoral and tibial sockets. Drill the femur 20 mm deep and the tibia approximately 30 mm deep to allow an extra 10 mm for tensioning.



Graft tube set (AR-1886-S)

Femoral Socket Preparation



01

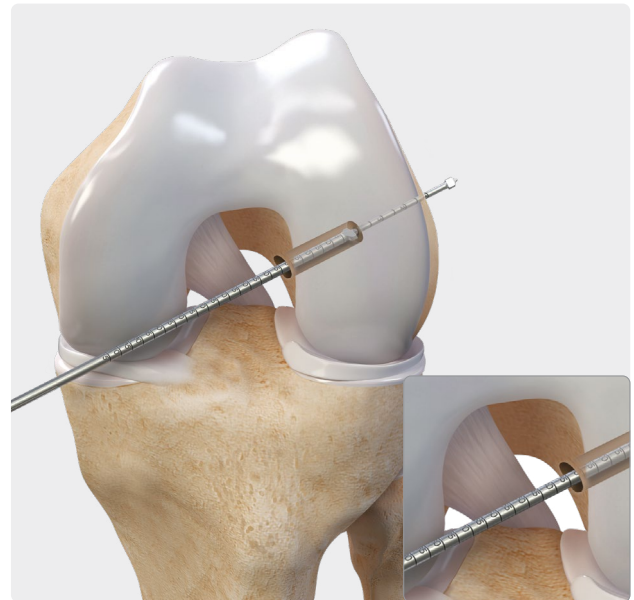

02

For medial portal drilling, use the TightRope® II drill pin, transportal ACL guides, and low-profile drills. Note the intraosseous length from the TightRope II drill pin. After socket drilling, pass a suture with the TightRope II drill pin for later graft passing.

Flexible Reamer Technique



01

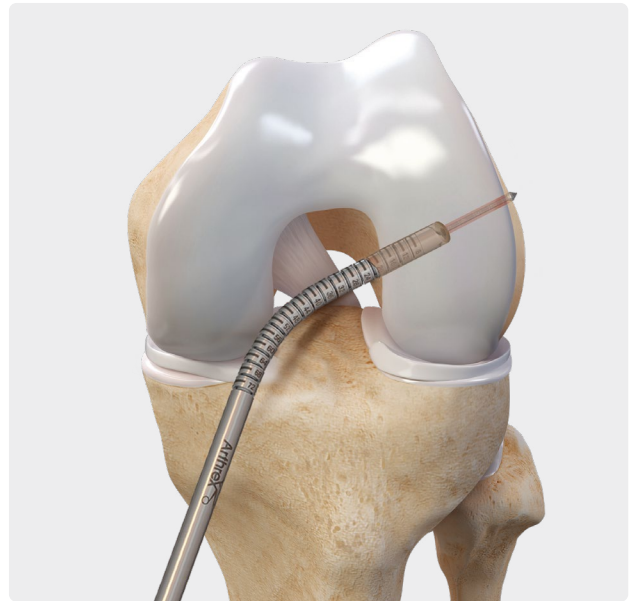

02

The Flexible Reamer System can be used for medial portal drilling using the flexible TightRope® pin, flexible reamer guide, and flexible low-profile drills. Note the intraosseous length from the flexible TightRope drill pin. After drilling the socket, pass a suture with the TightRope drill pin.

FlipCutter® III Drill Technique

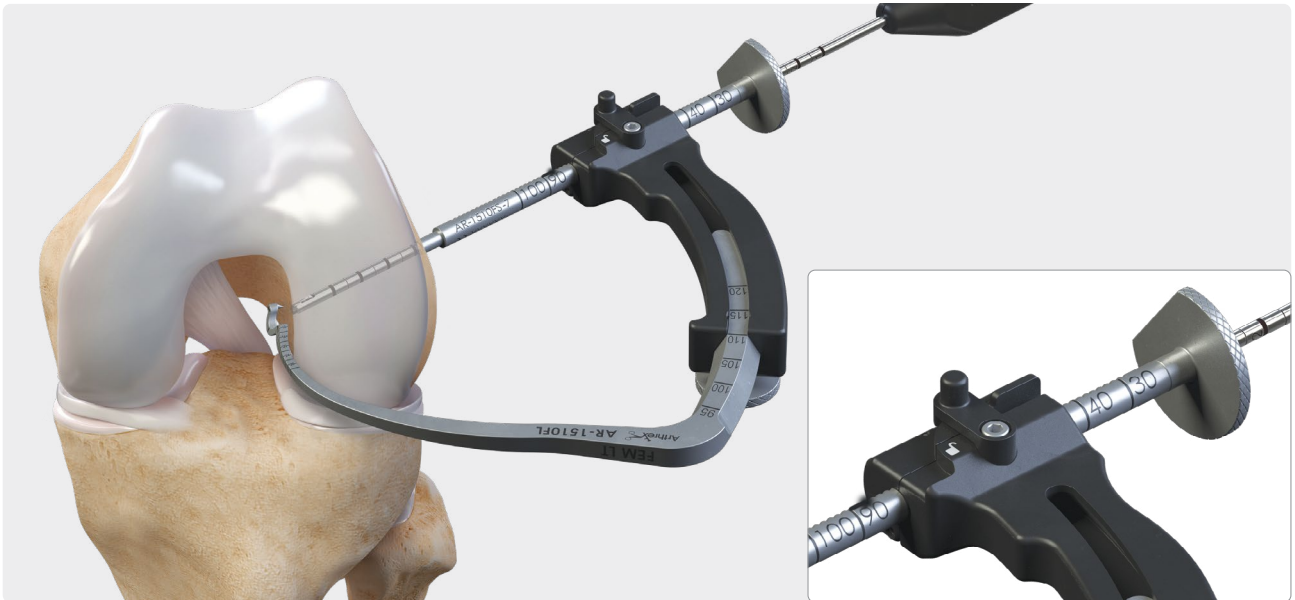

01

The FlipCutter III drill can alternatively be used to create the femoral socket. Place the guide into the joint and push the drill sleeve down to bone. Note the femoral measurement where the drill sleeve meets the guide. Drill the FlipCutter drill into the joint, remove the guide, and tap the stepped drill sleeve into bone.



02

Flip the blade on the FlipCutter® III drill and ream until the desired socket depth is reached, as measured on the FlipCutter drill markings.

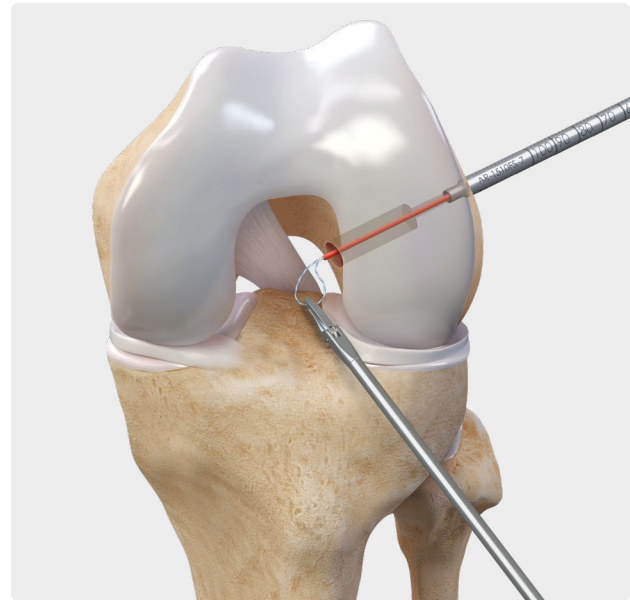

03

After drilling, flip the blade straight and remove it from the joint while keeping the drill sleeve in place. Pass a FiberSnare™ suture passer through the stepped drill sleeve and dock for later graft passing.

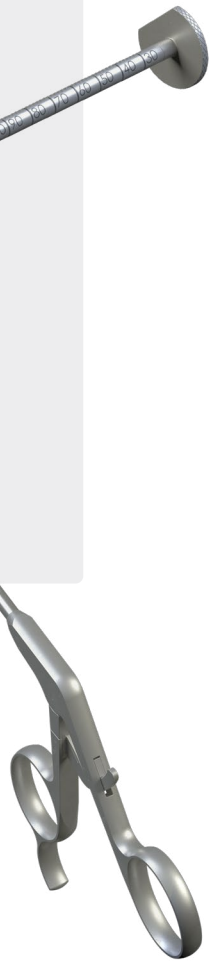

04

For tibial socket drilling, drill the FlipCutter III drill into the joint. Remove the marking hook and tap the stepped drill sleeve into the bone.

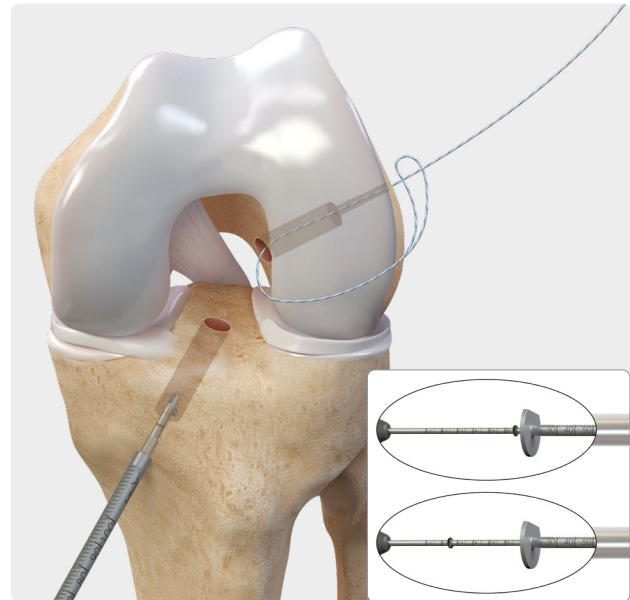

05

Flip the blade to the appropriate diameter for the tibial socket. Note the measurement where the drill sleeve meets the guide. Drill on forward with traction to cut the socket. Use the rubber grommet and 5 mm markings on the drill to measure the approximate socket depth.

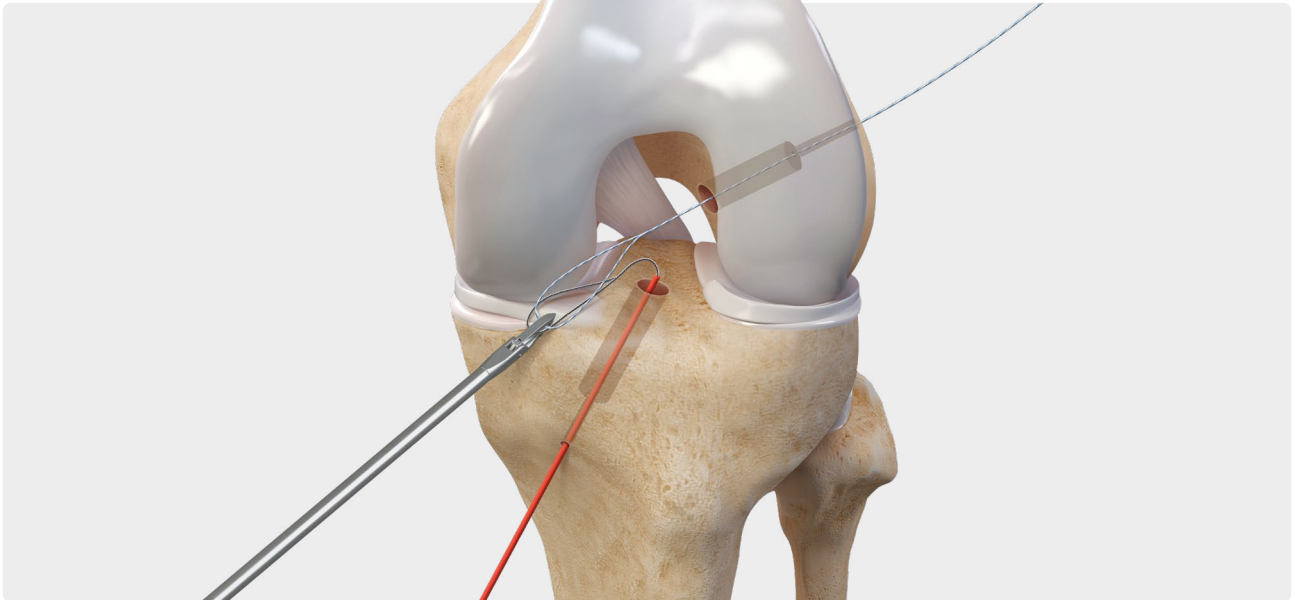

06

Straighten the FlipCutter® blade, remove it from the joint, and pass a different colored FiberSnare® suture passer into the joint. Retrieve the tibial and femoral FiberSnare sutures together from the medial portal with a suture retriever.

Technique pearl: Retrieving both sutures at the same time will help avoid a tissue bridge that can complicate graft passing.

Note: A PassPort Button™ cannula can also be used in the medial portal to prevent tangling.

All-Suture Button Graft Passing Technique

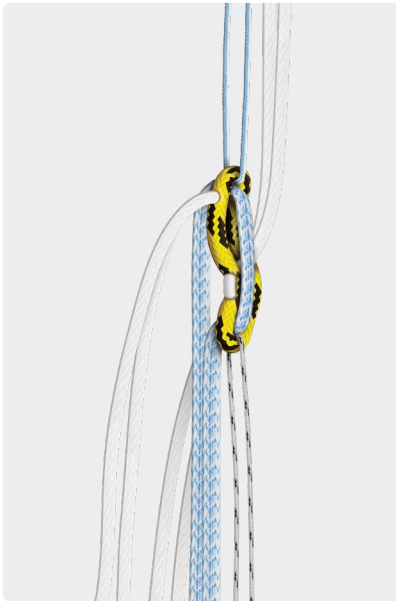

01

For proper deployment, the button should be oriented with only the blue passing suture and white tensioning strands toward the femur for shuttling, leaving behind the FiberTape® and TigerWire® sutures in line with the graft.

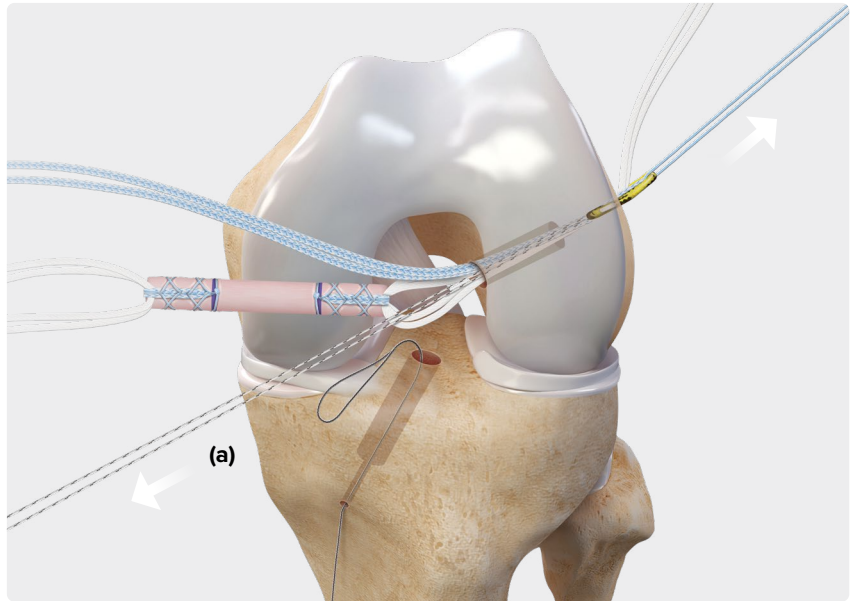

02

Pass the blue passing suture and white tensioning strands together through the femur. Keep the white-and-black TigerWire suture under tension to elongate the button (a). With equal tension, pull the blue passing suture and white tensioning strands together to advance the button through the lateral cortex. Pull on the inside of the tibial-sided TightRope® or the FiberTape suture to deploy the soft-button anchor. Marking the intraosseous length on the implant may be helpful to signal that the button has exited the femur. The button can also be viewed through the medial portal as it exits the femoral cortex.

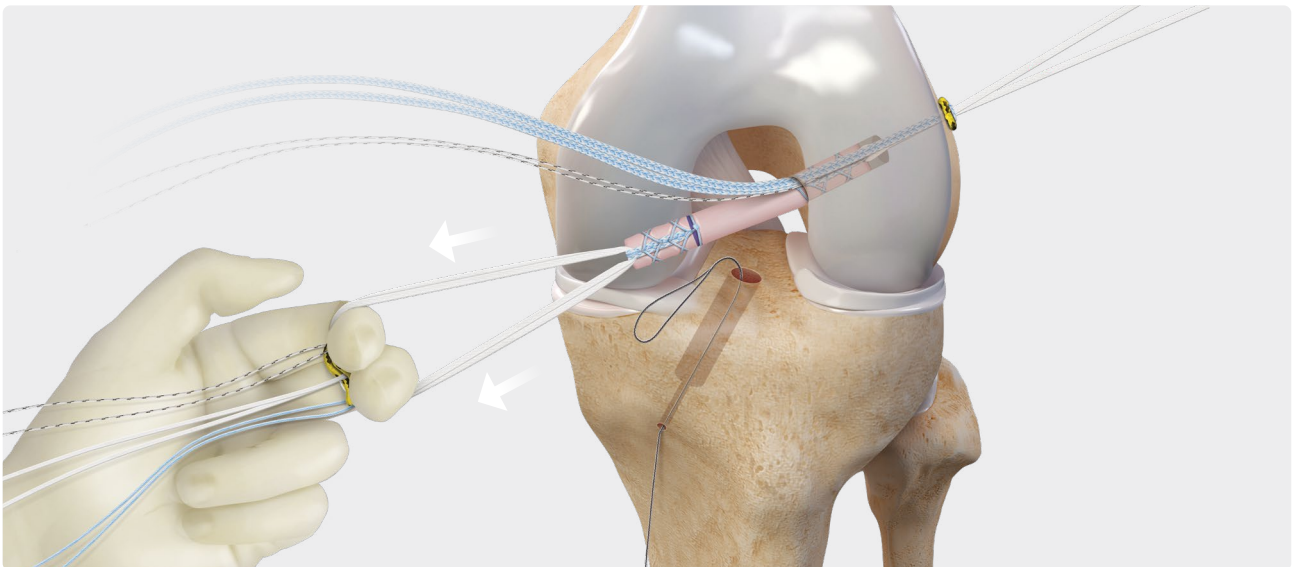

03

The FiberWire® and TigerWire sutures can be discarded from the button following its deployment on the femur. To advance the graft, pull on the tensioning strands one at a time, alternating approximately 2 cm on each side. Maintain slight tension during graft advancement by pulling on the inside of the tibial-sided TightRope suture loop.

Note: The graft can be fully seated into the femur or left partially inserted until tibial passing is complete. The latter option allows fine-tuning of graft depth in each socket.

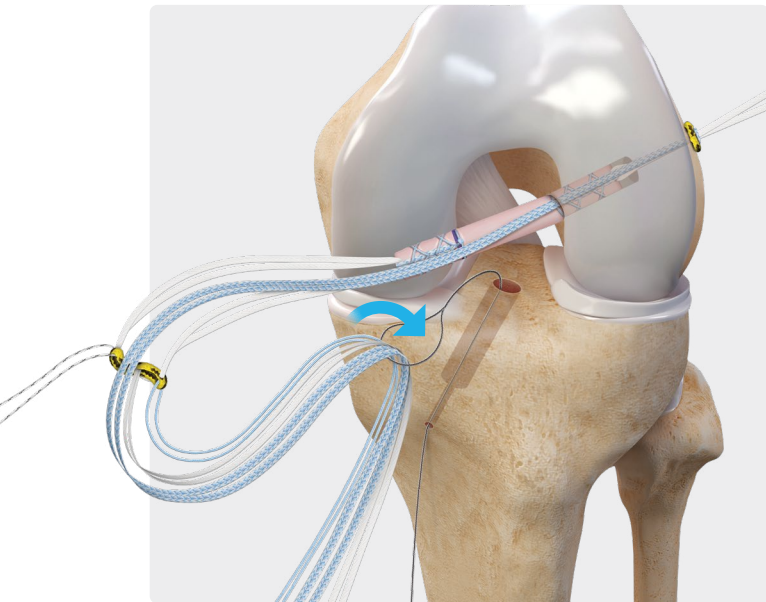

04

Load the white tensioning strands, blue passing suture, and FiberTape® sutures into the tibial FiberSnare® suture.

Note: The white-and-black TigerWire® suture should be left behind to facilitate elongation of the button.

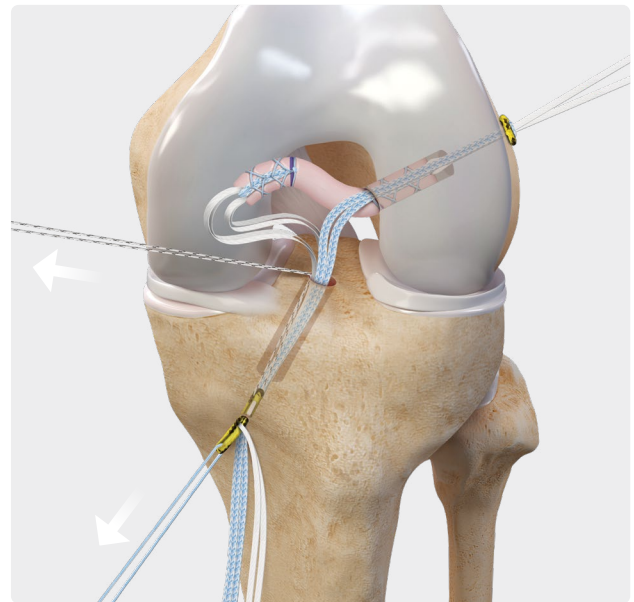

05

While maintaining tension on the TigerWire suture, pull distally on the tibial FiberSnare suture to advance both the FiberTag® TightRope® SB implant and FiberTape sutures out of the tibia distally.



06

Advance the graft into the tibia by pulling on the inside of the FiberTag TightRope SB loop. The TigerWire and FiberWire® sutures can be discarded.

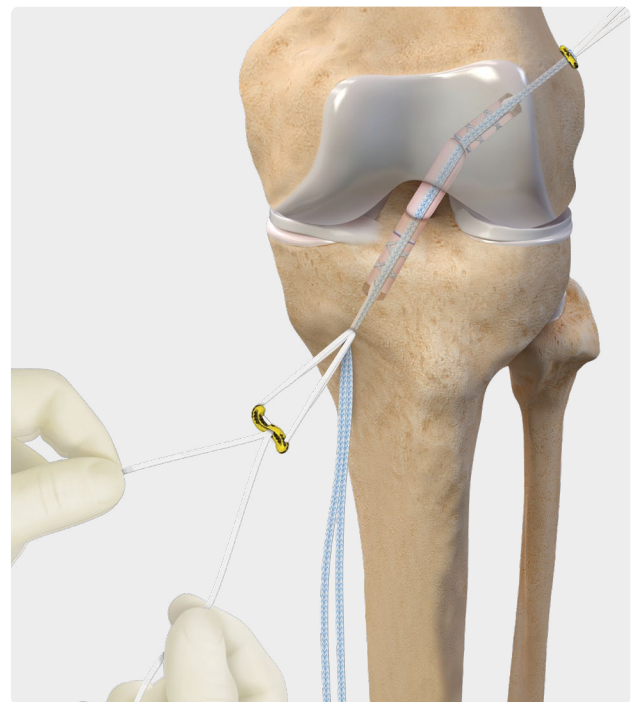

07

Pull on the white shortening strands to advance the all-suture button to bone and tension the graft in full extension.

Note: Ensure the button has a clear path to bone so as to not entrap soft tissue beneath it.

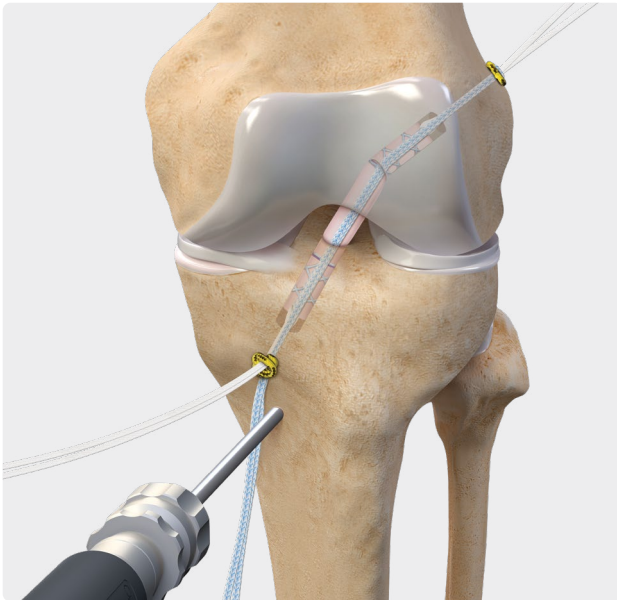

08

Use the spade-tip drill from the ACL Backup Kit to drill into the tibia to the depth of the drill collar.

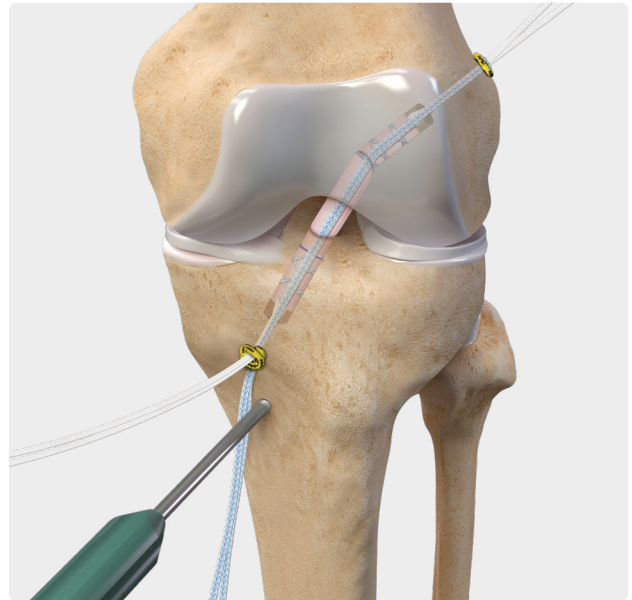

09

Use the disposable 5.2 mm tap to prepare the drill hole.

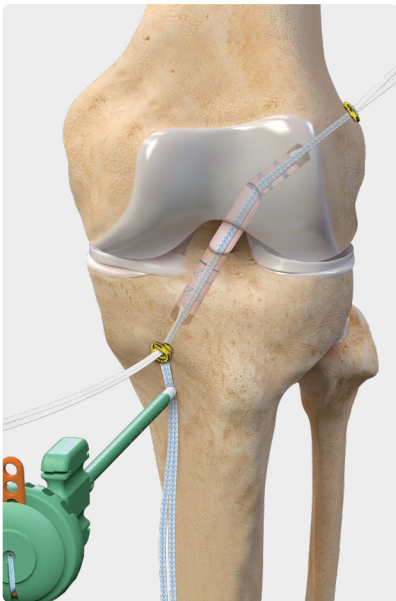

10

With the leg in full extension, pass the FiberTape® suture through the eyelet of the 4.75 mm BioComposite SwiveLock® anchor. Push the anchor into the drill hole until the eyelet is fully seated. Maintain tension on the suture limbs and screw the biocomposite anchor into the tibia. After removing the driver, remove the retention suture from the anchor.

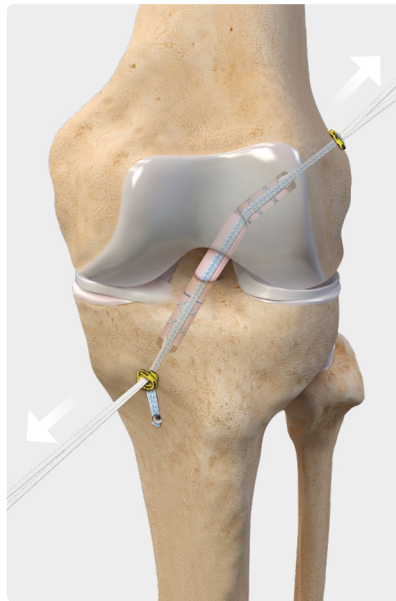

11

The FiberTag® TightRope® SB implant can be fully tensioned in the femur. After the knee is cycled several times, both TightRope implants can be tensioned again with the knee in extension.



12

Final fixation: After final tensioning is complete, cut flush the TightRope® implant shortening strands.

Ordering Information

Implants

FiberTag® TightRope® SB implant w/ attached needle, w/ FiberTape® suture for the <i>InternalBrace™</i> technique	AR-1588SBR-RTT-IB
FiberTag TightRope SB implant w/ attached needle, w/ radiopaque FiberTape suture for the <i>InternalBrace</i> technique	AR-1588SBR-RTT-IBR
FiberTag TightRope SB implant w/ attached needle	AR-1588SBR-RTT
SwiveLock® Anchor Fixation Implant Systems	
Implant System, secondary fixation w/ BioComposite SwiveLock anchor 4.75 mm × 19.1 mm	AR-1593-BC
Implant System, secondary fixation w/ PEEK SwiveLock anchor 4.75 mm × 19.1 mm	AR-1593-P

Instruments

GraftClamp graft preparation instrument	AR-2386T
QuadPro™ harvester, 8 mm	AR-2386-08
QuadPro harvester, 9 mm	AR-2386-09
QuadPro harvester, 10 mm	AR-2386-10
QuadPro harvester, 11 mm	AR-2386-11
FlipCutter® III drill	AR-1204FF
RetroConstruction™ drill guide set	AR-1510S
GraftPro® graft preparation set	AR-2950DS
Graft tube set	AR-1886-S
Pin-tip tibial marking hook ACL guide, small angle	AR-1510GTS
Footprint femoral ACL guide, small angle, right	AR-1510FRS
Footprint femoral ACL guide, small angle, left	AR-1510FLS

Suture

#2 FiberSnare® suture, 26 in length w/ 2 in closed loop (white/blue)	AR-7209SNL
#2 FiberSnare suture, 26 in length w/ 2 in closed loop (black/white)	AR-7209SNT
FiberLoop® 1.3 mm SutureTape suture, white/blue, looped w/ needle	AR-7534
TigerLoop™ 1.3 mm SutureTape suture, white/black, looped w/ needle	AR-7534T
FiberLink™ 1.3 mm SutureTape suture, white/blue, looped w/ closed loop	AR-7535
0.9 mm SutureTape Loop 20 in, white/blue, w/ 1/2 curved tapered needle	AR-7524C

Accessories

PassPort Button™ cannula, 8 mm ID × 2 cm	AR-6592-8-20
PassPort Button cannula, 8 mm ID × 3 cm	AR-6592-8-30
PassPort Button cannula, 10 mm ID × 2 cm	AR-6592-10-20
PassPort Button cannula, 10 mm ID × 3 cm	AR-6592-10-30
Suture retriever	AR-12540

Products advertised in this brochure / surgical technique guide may not be available in all countries. For information on availability, please contact Arthrex Customer Service or your local Arthrex representative.

References

1. Arthrex, Inc. Data on file (APT-06135). Naples, FL; 2022.
2. Arthrex, Inc. LA1-00038-EN_B. Naples, FL; 2017.
3. Daniel AV, Wijdicks CA, Smith PA. Reduced incidence of revision anterior cruciate ligament reconstruction with internal brace augmentation. *Orthop J Sports Med.* 2023;11(7):23259671231178026. doi:10.1177/23259671231178026
4. Daniel AV, Smith PA. Primary all-soft tissue quadriceps tendon autograft anterior cruciate ligament reconstruction with suture tape augmentation resulted in satisfactory patient outcomes and a low graft failure rate in high school and collegiate athletes. *Arthroscopy.* 2025;41(1):95-105. doi:10.1016/j.arthro.2024.02.047
5. Wilson WT, Kennedy MJ, MacLeod D, Hopper GP, MacKay GM. Outcomes of anterior cruciate ligament reconstruction with independently tensioned suture tape augmentation at 5-year follow-up. *Am J Sports Med.* 2023;51(14):3658-3664. doi:10.1177/03635465231207623
6. Daniel AV, Smith PA. Less subsequent revision anterior cruciate ligament (ACL) reconstruction following primary bone-patellar tendon-bone ACL reconstruction with suture tape augmentation—a retrospective comparative therapeutic trial with 5-year follow-up. *Arthroscopy.* 2024;40(9):2455-2464. doi:10.1016/j.arthro.2024.01.019
7. Bodendorfer BM, Michaelson EM, Shu HT, et al. Suture augmented versus standard anterior cruciate ligament reconstruction: a matched comparative analysis. *Arthroscopy.* 2019;35(7):2114-2122. doi:10.1016/j.arthro.2019.01.054

This description of technique is provided as an educational tool and clinical aid to assist properly licensed medical professionals in the usage of specific Arthrex products. As part of this professional usage, the medical professional must use their professional judgment in making any final determinations in product usage and technique. In doing so, the medical professional should rely on their own training and experience, and should conduct a thorough review of pertinent medical literature and the product's directions for use. Postoperative management is patient-specific and dependent on the treating professional's assessment. Individual results will vary and not all patients will experience the same postoperative activity level or outcomes.



Arthrex manufacturer, authorized representative, and importer information (Arthrex eFUs)



US patent information