

# Arthroplasty

Next Generation in Repair and Reconstruction



---

## Helping Surgeons Treat Their Patients Better<sup>®</sup>

---

Since its inception, Arthrex has been committed to one mission: Helping Surgeons Treat Their Patients Better. We are strategically focused on constant product innovation through scientific research, surgeon collaboration, and medical education to make less invasive surgical procedures simple, safer and more reproducible. Each year, we develop more than 1,000 new innovative products and procedures to advance minimally invasive orthopedics worldwide.

Arthrex has always remained a privately held company, which allows for the rapid evaluation of new technologies and ideas and the freedom to develop products and techniques that truly make a difference. Our experienced team of dedicated professionals represents a shared passion and commitment to delivering uncompromising quality to the health care providers who use our products and the millions of patients whose lives we impact.

The medical significance of our contributions serves as our primary benchmark of success and will continue into the future as the legacy of Arthrex.

---

## Table of Contents

---

Shoulder Arthroplasty .....	05
Knee Arthroplasty .....	63



# Shoulder Arthroplasty

Solutions for Partial and Total Shoulder Replacement

Eclipse™ Total Shoulder System .....	06
Eclipse™ Shoulder Instrument Case .....	08
Eclipse™ SpeedScap™ Implant System (AR-9400SBK).....	10
Univers™ II/Univers Apex OptiFit™/Univers Apex Total Shoulder Systems.....	11
Univers™ II Humeral Preparation Set.....	13
Univers™ Apex Humeral Preparation Set.....	14
Univers™ II/Apex Combined Humeral Preparation.....	15
Univers VaultLock® Glenoid System.....	17
Keeled Glenoid.....	18
Univers VaultLock® and Keel Glenoid Instrument Set.....	19
Univers VaultLock® Augmented Glenoid System.....	21
Universal Glenoid™ Convertible Baseplate.....	26
Universal Glenoid™ Instrument Set.....	27
Univers Revers™ Total Shoulder System .....	30
Univers Revers™ Apex Humeral Instrumentation Set.....	32
Univers Revers™ Humeral Broach Instrumentation Set.....	33
Univers Revers™ CA Head and Adapter Trials.....	37
Univers Revers™ Modular Glenoid System.....	39
Bone Graft Preparation for the Univers Revers™ Modular Glenoid System (AR-9665S).....	46
Univers Revers™ Augmented Modular Glenoid System.....	48
Augmented Modular Glenoid System Instrument Set.....	50
Univers Revers™ Fracture Adapter.....	52
FxBridge™ Tuberosity Repair System (AR-9517).....	54
Shoulder Arthroplasty Retractor Set .....	55
Virtual Implant Positioning™ (VIP™) System .....	58
Glenoid Targeter Instrument Set.....	59
VIP™ Glenoid Reaming System Set.....	60



**Stemless Anatomic Shoulder Prosthesis**

- Individual anatomic reconstruction of the humeral head—the prosthesis is adjusted to the cortical rim of the humeral resection at the anatomical neck
- Humeral head can be positioned independently from humeral shaft axis—particularly important in post-traumatic arthritis cases
- Variable humeral head heights for anatomic reconstruction
- Preserved bone in the humeral shaft enables primary-like setting in the event of revision arthroplasty
- Potential for less invasive exposure
- More than a decade of long-term survivorship data<sup>1</sup>
- Proprietary cage-screw fixation provides dynamic compression at the bone-prosthesis interface and reduces medial calcar osteolysis<sup>2</sup>
- Streamlined 3-step implantation

Humeral Heads	37 mm-55 mm (2 mm increments) Humeral heads offered in cobalt-chrome and titanium (special order)
Heights	Anatomic and Extended (+2 mm) <b>Note: Only one head height is available for 37 mm</b>
Cage Screw	<b>Small:</b> 30 mm <b>Medium:</b> 35 mm <b>Large:</b> 40 mm <b>X-Large:</b> 45 mm
Trunnion	37 mm-55 mm (sized with humeral head)

## Eclipse™ Total Shoulder System (Cont.)

### Implants

Product Description	Item Number
<b>Trunnions</b>	
Eclipse Trunnion, slotted, 37 mm, TPS- and CaP-coated	AR-9301-37CPC
Eclipse Trunnion, slotted, 39 mm, TPS- and CaP-coated	AR-9301-39CPC
Eclipse Trunnion, slotted, 41 mm, TPS- and CaP-coated	AR-9301-41CPC
Eclipse Trunnion, slotted, 43 mm, TPS- and CaP-coated	AR-9301-43CPC
Eclipse Trunnion, slotted, 45 mm, TPS- and CaP-coated	AR-9301-45CPC
Eclipse Trunnion, slotted, 47 mm, TPS- and CaP-coated	AR-9301-47CPC
Eclipse Trunnion, slotted, 49 mm, TPS- and CaP-coated	AR-9301-49CPC
Eclipse Trunnion, slotted, 51 mm, TPS- and CaP-coated	AR-9301-51CPC
Eclipse Trunnion, slotted, 53 mm, TPS- and CaP-coated	AR-9301-53CPC
Eclipse Trunnion, slotted, 55 mm, TPS- and CaP-coated	AR-9301-55CPC
<b>Cage Screws</b>	
Eclipse Cage Screw, 30 mm, small	AR-9301-01
Eclipse Cage Screw, 35 mm, medium	AR-9301-02
Eclipse Cage Screw, 40 mm, large	AR-9301-03
Eclipse Cage Screw, 45 mm, x-large	AR-9301-04
<b>CoCr Humeral Heads</b>	
Eclipse Humeral Head, 37 mm/16 mm	AR-9337-16
Eclipse Humeral Head, 39 mm/16 mm	AR-9339-16
Eclipse Humeral Head, 39 mm/18 mm	AR-9339-18
Eclipse Humeral Head, 41 mm/18 mm	AR-9341-16
Eclipse Humeral Head, 41 mm/16 mm	AR-9341-18
Eclipse Humeral Head, 43 mm/16 mm	AR-9343-16
Eclipse Humeral Head, 43 mm/18 mm	AR-9343-18
Eclipse Humeral Head, 45 mm/17 mm	AR-9345-17
Eclipse Humeral Head, 45 mm/19 mm	AR-9345-19
Eclipse Humeral Head, 47 mm/18 mm	AR-9347-18
Eclipse Humeral Head, 47 mm/20 mm	AR-9347-20
Eclipse Humeral Head, 49 mm/18 mm	AR-9349-18
Eclipse Humeral Head, 49 mm/20 mm	AR-9349-20
Eclipse Humeral Head, 51 mm/19 mm	AR-9351-19
Eclipse Humeral Head, 51 mm/21 mm	AR-9351-21
Eclipse Humeral Head, 53 mm/20 mm	AR-9353-20
Eclipse Humeral Head, 53 mm/22 mm	AR-9353-22
Eclipse Humeral Head, 55 mm/21 mm	AR-9355-21
Eclipse Humeral Head, 55 mm/23 mm	AR-9355-23
<b>Titanium Humeral Heads</b>	
Eclipse Titanium Humeral Head, 37 mm/16 mm	AR-9337-16T
Eclipse Titanium Humeral Head, 39 mm/16 mm	AR-9339-16T
Eclipse Titanium Humeral Head, 41 mm/16 mm	AR-9341-16T
Eclipse Titanium Humeral Head, 43 mm/16 mm	AR-9343-16T
Eclipse Titanium Humeral Head, 45 mm/17 mm	AR-9345-17T
Eclipse Titanium Humeral Head, 47 mm/18 mm	AR-9347-18T
Eclipse Titanium Humeral Head, 49 mm/18 mm	AR-9349-18T
Eclipse Titanium Humeral Head, 51 mm/19 mm	AR-9351-19T
Eclipse Titanium Humeral Head, 53 mm/20 mm	AR-9353-20T
Eclipse Titanium Humeral Head, 55 mm/21 mm	AR-9355-21T

### Disposables

Product Description	Item Number
Eclipse and Univers™ II Pin Set	AR-9207S
Eclipse Sterile Cage Screw Sizer	AR-9401-08S

## Eclipse™ Shoulder Instrument Case



### Eclipse Shoulder Instrument Case - Top Tray (AR-9400S)

Label	Product Description	Item Number	Label	Product Description	Item Number
1	Eclipse Coring Template, 37 mm	AR-9400-37	8	Eclipse Trial Head, 37 mm/16 mm	AR-9437-16
	Eclipse Coring Template, 39 mm	AR-9400-39		Eclipse Trial Head, 39 mm/16 mm	AR-9439-16
	Eclipse Coring Template, 41 mm	AR-9400-41		Eclipse Trial Head, 39 mm/18 mm	AR-9439-18
	Eclipse Coring Template, 43 mm	AR-9400-43		Eclipse Trial Head, 41 mm/16 mm	AR-9441-16
	Eclipse Coring Template, 45 mm	AR-9400-45		Eclipse Trial Head, 41 mm/18 mm	AR-9441-18
	Eclipse Coring Template, 47 mm	AR-9400-47		Eclipse Trial Head, 43 mm/16 mm	AR-9443-16
	Eclipse Coring Template, 49 mm	AR-9400-49		Eclipse Trial Head, 43 mm/18 mm	AR-9443-18
	Eclipse Coring Template, 51 mm	AR-9400-51		Eclipse Trial Head, 45 mm/17 mm	AR-9445-17
	Eclipse Coring Template, 55 mm	AR-9400-55		Eclipse Trial Head, 45 mm/19 mm	AR-9445-19
2	Univers™ and Eclipse Handle for Drilling Template	AR-9203-10		Eclipse Trial Head, 47 mm/18 mm	AR-9447-18
3	Eclipse Cage Screw Sizer	AR-9401-08		Eclipse Trial Head, 47 mm/20 mm	AR-9447-20
4	Eclipse Resection Protector, 40 mm, small	AR-9401-40		Eclipse Trial Head, 49 mm/18 mm	AR-9449-18
	Eclipse Resection Protector, 46 mm, medium	AR-9401-46		Eclipse Trial Head, 49 mm/20 mm	AR-9449-20
	Eclipse Resection Protector, 50 mm, large	AR-9401-50		Eclipse Trial Head, 51 mm/19 mm	AR-9451-19
	Eclipse Resection Protector, 55 mm, extra large	AR-9401-55		Eclipse Trial Head, 51 mm/21 mm	AR-9451-21
5	Eclipse Trial Trunnion	AR-9401-18		Eclipse Trial Head, 53 mm/20 mm	AR-9453-20
6	Eclipse Coring Reamer	AR-9401-02		Eclipse Trial Head, 53 mm/22 mm	AR-9453-22
7	Eclipse Centering Device	AR-9401-09		Eclipse Trial Head, 55 mm/21 mm	AR-9455-21
				Eclipse Trial Head, 55 mm/23 mm	AR-9455-23



## Eclipse™ Shoulder Instrument Case (Cont.)

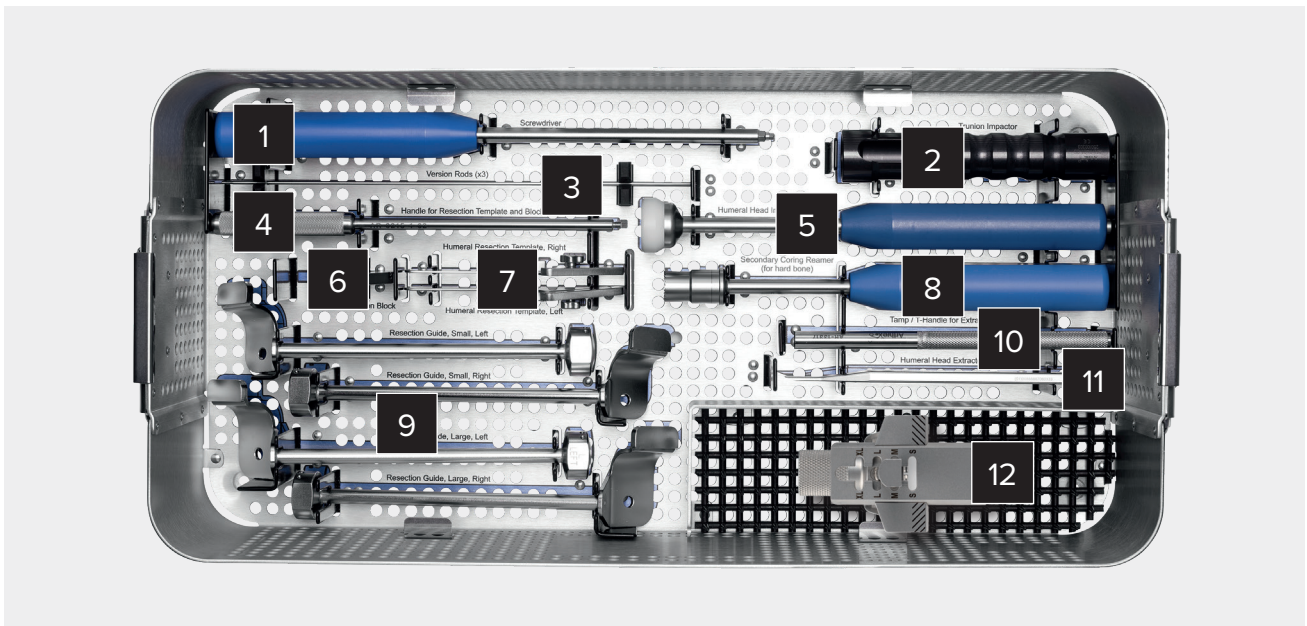

### Eclipse Shoulder Instrument Case - Bottom Tray (AR-9400S)

Label	Product Description	Item Number
1	Eclipse Screwdriver	AR-9401-03
2	Eclipse Trunion Impactor	AR-9401-05
3	Eclipse and Univers™ Orientation Pin for Resection Guide	AR-9202
4	Handle for Resection Templates	AR-9215-1-02
5	Univers and Eclipse Handle for Head Impactor	AR-9203-13
6	Univers II and Eclipse Humeral Resection Block	AR-9205
7	Humeral Resection Template, left Humeral Resection Template, right	AR-9200-01L AR-9200-01R
8	Eclipse Coring Reamer, secondary	AR-9401-02L
9	Eclipse and Univers II Resection Guide, small, left Eclipse and Univers II Resection Guide, small, right Eclipse and Univers II Resection Guide, large, left Eclipse and Univers II Resection Guide, large, right	AR-9401-10 AR-9401-11 AR-9401-12 AR-9401-13
10	Bone Graft Tamp	AR-13317
11	Eclipse Humeral Head Extractor	AR-9401-17
12	Eclipse Trunion Adapter	AR-9402

## Eclipse™ SpeedScap™ Implant System (AR-9400SBK)



- Contains all components needed to perform a knotless double-row subscapularis repair during stemless anatomic total shoulder arthroplasty
- FiberTak® DR and 3.9 mm SwiveLock® anchors, along with their appropriate drills, are designed for open shoulder surgery by incorporating a shorter driving and shaft length compared to those designed for arthroscopic shoulder surgery
- SutureTape link and free needle are included for easy passage of repair sutures through the subscapularis
- Two 1.3 mm SutureTapes are included for tensioning sutures during subscapularis release (peel) and rotator interval closure at the end of the operation

Product Description	Item Number
Eclipse SpeedScap Implant System	AR-9400-SBK
Eclipse Targeting Adapter	AR-9402

## Univers™ II/Univers Apex OptiFit™/Univers Apex Total Shoulder Systems

### Anatomic Shoulder Prosthesis: Individually Adaptable to Anatomical Variations of the Proximal Humerus

- Variable inclination (125°-140°) and version ( $\pm 10^\circ$ )
- Anatomic reconstruction
- Multiple head diameters and heights
- Eccentric humeral head options (3.5 mm offset)
- Humeral heads offered in cobalt-chrome and titanium
- OptiFit stem offers Titanium Plasma Spray (TPS) coating and a midsize length for ingrowth and additional stability



Inclination

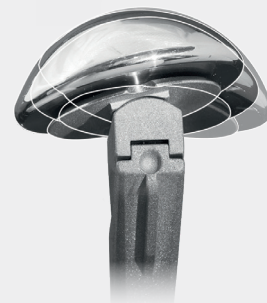

Version



Offset

## Univers™ II/Univers Apex OptiFit™/Univers Apex Total Shoulder Systems (Cont.)

### Implants

Product Description	Item Number
Univers II/Apex Trunnion Replacement Kit	AR-9100TK
<b>Stems</b>	
Univers II Humeral Stem, 5 mm/105 mm	AR-9100-05P
Univers II Humeral Stem, 6 mm/115 mm	AR-9100-06P
Univers II Humeral Stem, 7 mm/140 mm	AR-9100-07P
Univers II Humeral Stem, 8 mm/143 mm	AR-9100-08P
Univers II Humeral Stem, 9 mm/146 mm	AR-9100-09P
Univers II Humeral Stem, 10 mm/148 mm	AR-9100-10P
Univers II Humeral Stem, 11 mm/151 mm	AR-9100-11P
Univers II Humeral Stem, 12 mm/151 mm	AR-9100-12P
Univers II Humeral Stem, 13 mm/151 mm	AR-9100-13P
Univers II Humeral Stem, 14 mm/151 mm	AR-9100-14P
Univers II Humeral Stem, 15 mm/151 mm	AR-9100-15P
Univers Apex OptiFit Humeral Stem, 5 mm/85 mm	AR-9100-05M
Univers Apex OptiFit Humeral Stem, 6 mm/85 mm	AR-9100-06M
Univers Apex OptiFit Humeral Stem, 7 mm/85 mm	AR-9100-07M
Univers Apex OptiFit Humeral Stem, 8 mm/85 mm	AR-9100-08M
Univers Apex OptiFit Humeral Stem, 9 mm/85 mm	AR-9100-09M
Univers Apex OptiFit Humeral Stem, 10 mm/85 mm	AR-9100-10M
Univers Apex OptiFit Humeral Stem, 11 mm/85 mm	AR-9100-11M
Univers Apex OptiFit Humeral Stem, 12 mm/85 mm	AR-9100-12M
Univers Apex OptiFit Humeral Stem, 13 mm/85 mm	AR-9100-13M
Univers Apex Humeral Stem, 5 mm/60 mm, 132.5° fixed	AR-9100-05S
Univers Apex Humeral Stem, 6 mm/60 mm	AR-9100-06S
Univers Apex Humeral Stem, 7 mm/60 mm	AR-9100-07S
Univers Apex Humeral Stem, 8 mm/60 mm	AR-9100-08S
Univers Apex Humeral Stem, 9 mm/60 mm	AR-9100-09S
Univers Apex Humeral Stem, 10 mm/60 mm	AR-9100-10S
Univers Apex Humeral Stem, 11 mm/60 mm	AR-9100-11S
Univers Apex Humeral Stem, 12 mm/60 mm	AR-9100-12S
Univers Apex Humeral Stem, 13 mm/65 mm	AR-9100-13S
Univers Apex Humeral Stem, 14 mm/65 mm	AR-9100-14S
Univers Apex Humeral Stem, 15 mm/65 mm	AR-9100-15S
<b>CoCr Humeral Heads</b>	
Univers II Humeral Head, 40 mm/17 mm	AR-9140-17P
Univers II Humeral Head, 42 mm/17 mm	AR-9142-17P
Univers II Humeral Head, 44 mm/17 mm	AR-9144-17P
Univers II Humeral Head, 44 mm/19 mm	AR-9144-19P
Univers II Humeral Head, 46 mm/18 mm	AR-9146-18P
Univers II Humeral Head, 46 mm/20 mm	AR-9146-20P
Univers II Humeral Head, 48 mm/19 mm	AR-9148-19P
Univers II Humeral Head, 48 mm/21 mm	AR-9148-21P
Univers II Humeral Head, 50 mm/19 mm	AR-9150-19P
Univers II Humeral Head, 50 mm/21 mm	AR-9150-21P
Univers II Humeral Head, 52 mm/20 mm	AR-9152-20P
Univers II Humeral Head, 52 mm/22 mm	AR-9152-22P
Univers II Humeral Head, 54 mm/21 mm	AR-9154-21P
Univers II Humeral Head, 54 mm/23 mm	AR-9154-23P
Univers II Humeral Head, 56 mm/22 mm	AR-9156-22P
Univers II Humeral Head, 56 mm/24 mm	AR-9156-24P

Product Description	Item Number
<b>Titanium Humeral Heads</b>	
Univers II Titanium Humeral Head, 40 mm/17 mm	AR-9140-17T
Univers II Titanium Humeral Head, 42 mm/17 mm	AR-9142-17T
Univers II Titanium Humeral Head, 44 mm/17 mm	AR-9144-17T
Univers II Titanium Humeral Head, 46 mm/18 mm	AR-9146-18P
Univers II Titanium Humeral Head, 48 mm/19 mm	AR-9148-19T
Univers II Titanium Humeral Head, 50 mm/19 mm	AR-9150-19T
Univers II Titanium Humeral Head, 52 mm/20 mm	AR-9152-20T
Univers II Titanium Humeral Head, 54 mm/21 mm	AR-9154-21T
Univers II Titanium Humeral Head, 56 mm/22 mm	AR-9156-22T
<b>Cuff Arthropathy Humeral Heads</b>	
Univers CA Humeral Head, 42 mm/17 mm	AR-9142-17CA
Univers CA Humeral Head, 44 mm/17 mm	AR-9144-17CA
Univers CA Humeral Head, 44 mm/19 mm	AR-9144-19CA
Univers CA Humeral Head, 46 mm/18 mm	AR-9146-18CA
Univers CA Humeral Head, 46 mm/20 mm	AR-9146-20CA
Univers CA Humeral Head, 48 mm/19 mm	AR-9148-19CA
Univers CA Humeral Head, 48 mm/21 mm	AR-9148-21CA
Univers CA Humeral Head, 50 mm/19 mm	AR-9150-19CA
Univers CA Humeral Head, 50 mm/21 mm	AR-9150-21CA
Univers CA Humeral Head, 52 mm/20 mm	AR-9152-20CA
Univers CA Humeral Head, 52 mm/22 mm	AR-9152-22CA
Univers CA Humeral Head, 54 mm/21 mm	AR-9154-21CA
Univers CA Humeral Head, 54 mm/23 mm	AR-9154-23CA
Univers CA Humeral Head, 56 mm/22 mm	AR-9156-22CA
Univers CA Humeral Head, 56 mm/24 mm	AR-9156-24CA

### Disposables

Product Description	Item Number
#2 FiberWire® Suture (blue), 97 cm, w/ tapered needle, 26.5 mm, ½ circle	AR-7200
#2 FiberWire Suture (blue), 97 cm, w/ reverse cutting needle, 36.6 mm, ½ circle	AR-7202
#5 FiberWire Suture (blue), 97 cm	AR-7210
#5 FiberWire Suture (blue), 97 cm, w/ conventional cutting needle, 48 mm, ½ circle	AR-7211
FiberWire Suture Kit	AR-7219
FiberTape® Tendon Compression Bridge Kit	AR-7297
Univers Apex Suture Kit	AR-7298
Eclipse™ and Univers II Pin Set	AR-9207S

## Univers™ II Humeral Preparation Set

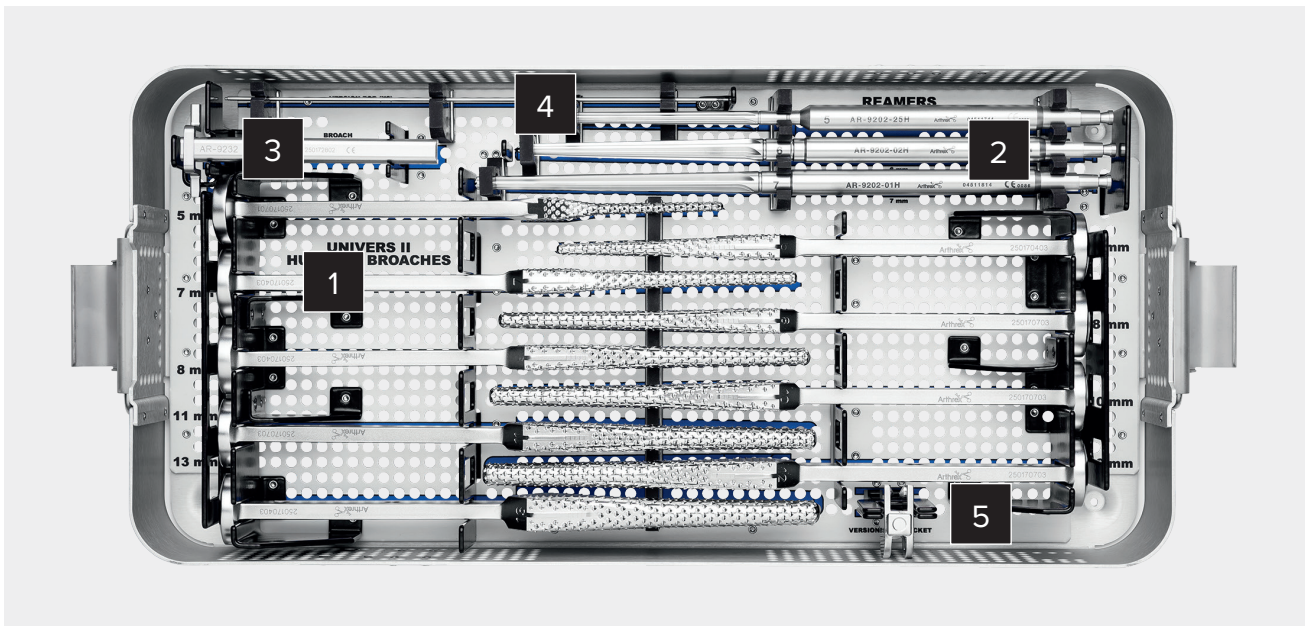

### Univers II Humeral Preparation Set (AR-9226UBS)

Label	Product Description	Item Number
1	Univers II Broach, 5 mm	AR-9231-05
	Univers II Broach, 6 mm	AR-9231-06
	Univers II Broach, 7 mm	AR-9231-07
	Univers II Broach, 8 mm	AR-9231-08
	Univers II Broach, 9 mm	AR-9231-09
	Univers II Broach, 10 mm	AR-9231-10
	Univers II Broach, 11 mm	AR-9231-11
	Univers II Broach, 12 mm	AR-9231-12
	Univers II Broach, 13 mm	AR-9231-13
2	Univers II Reamer, 5 mm	AR-9202-25H
	Univers II Reamer, 6 mm	AR-9202-02H
	Univers II Reamer, 7 mm	AR-9202-01H
3	Univers II Guide for Humeral Broach	AR-9232
4	Univers/Eclipse™ Orientation Pin for Resection Guide	AR-9202
5	Univers II Version Rod Bracket for Broach	AR-9231-20

## Univers™ Apex Humeral Preparation Set

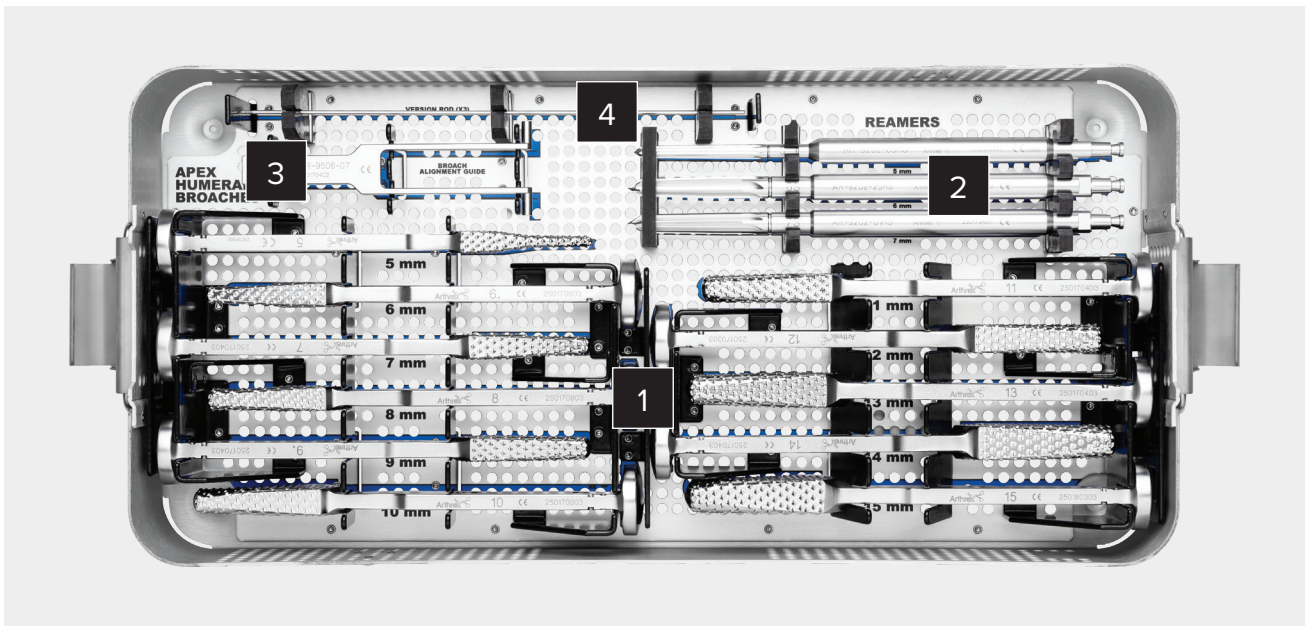

### Univers Apex Humeral Preparation Set (AR-9226ABS)

Label	Product Description	Item Number
1	Univers Apex Broach, 5 mm	AR-9231-05S
	Univers Apex Broach, 6 mm	AR-9231-06S
	Univers Apex Broach, 7 mm	AR-9231-07S
	Univers Apex Broach, 8 mm	AR-9231-08S
	Univers Apex Broach, 9 mm	AR-9231-09S
	Univers Apex Broach, 10 mm	AR-9231-10S
	Univers Apex Broach, 11 mm	AR-9231-11S
	Univers Apex Broach, 12 mm	AR-9231-12S
	Univers Apex Broach, 13 mm	AR-9231-13S
	Univers Apex Broach, 14 mm	AR-9231-14S
	Univers Apex Broach, 15 mm	AR-9231-15S
2	Univers Apex Reamer, 5 mm	AR-9202-25HS
	Univers Apex Humeral Reamer, 6 mm	AR-9202-01HS
	Univers Apex Humeral Reamer, 7 mm	AR-9202-02HS
3	Univers Apex Humeral Broach Alignment Guide	AR-9506-07
4	Univers/Eclipse™ Orientation Pin for Resection Guide	AR-9202

## Univers™ II/Apex Combined Humeral Preparation

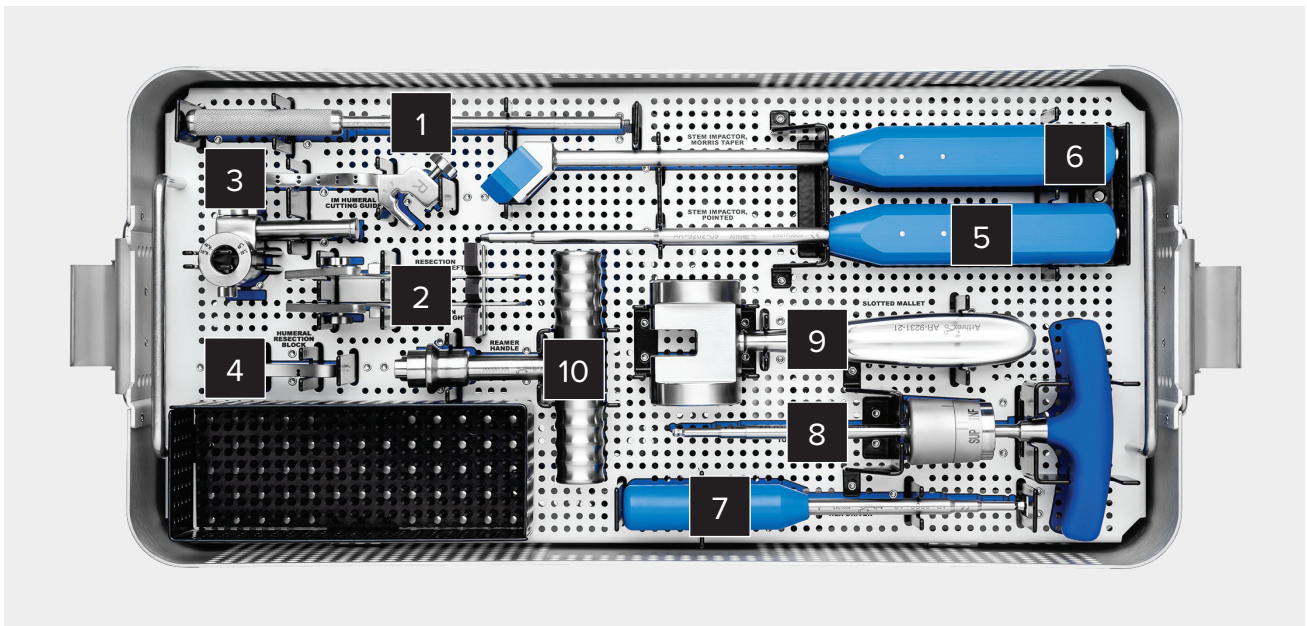

### Univers II/Apex Combined Humeral Preparation - Top Tray (AR-9226CC)

Label	Product Description	Item Number
1	Glenoid Drill Guide Handle	AR-9215-1-02
2	Humeral Resection Templates	AR-9200-01L/01R
3	Intramedullary Humeral Cutting Guide	AR-9401-14
4	Univers II/Eclipse Humeral Resection Block	AR-9205
5	Univers II Stem Impactor Pointed	AR-9202-09
6	Univers II Stem Impactor Morris Taper	AR-9202-09P
7	Univers Screwdriver	AR-9202-10
8	Univers II Torque Driver	AR-9224
9	Slotted Mallet, shoulder arthroplasty	AR-9231-21
10	Univers Reamer T-Handle, Hudson connect	AR-9202-15H

## Univers™ II/Apex Combined Humeral Set

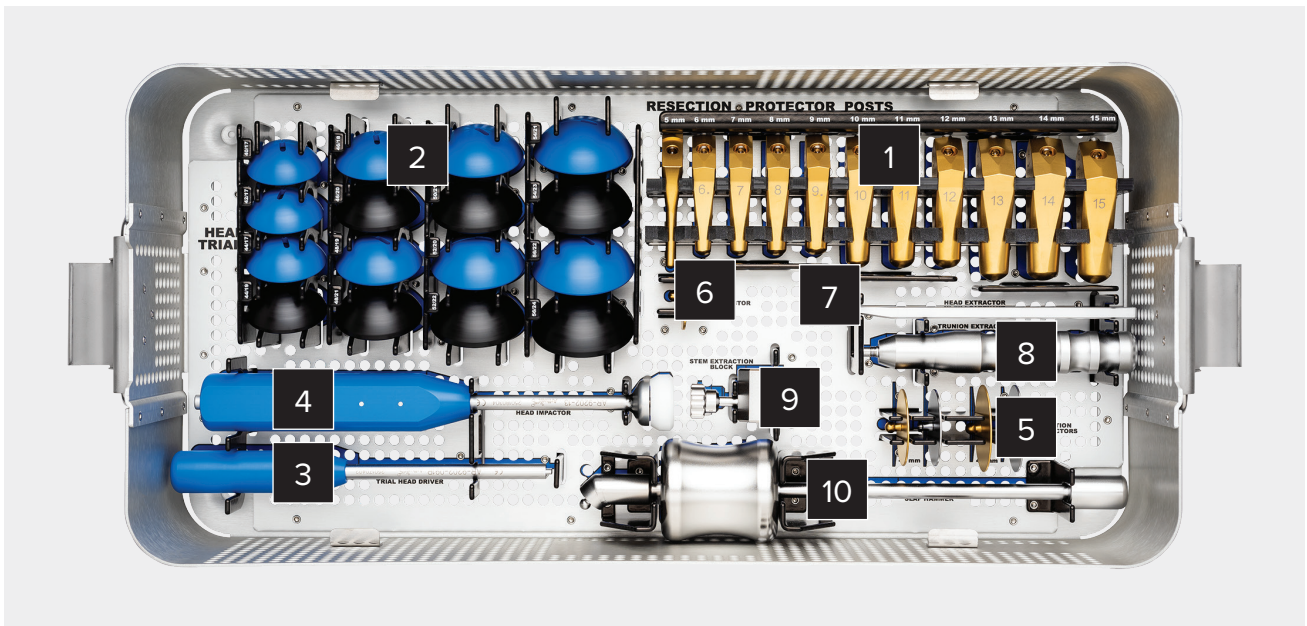

### Univers II/Apex Combined Humeral Set - Bottom Tray (AR-9226CS)

Label	Product Description	Item Number	
1	Univers Apex Protector Post, 5 mm	AR-9200-15S	
	Univers Apex Protector Post, 6 mm	AR-9200-16S	
	Univers Apex Protector Post, 7 mm	AR-9200-17S	
	Univers Apex Protector Post, 8 mm	AR-9200-18S	
	Univers Apex Protector Post, 9 mm	AR-9200-19S	
	Univers Apex Protector Post, 10 mm	AR-9200-20S	
	Univers Apex Protector Post, 11 mm	AR-9200-21S	
	Univers Apex Protector Post, 12 mm	AR-9200-22S	
	Univers Apex Protector Post, 13 mm	AR-9200-23S	
	Univers Apex Protector Post, 14 mm	AR-9200-24S	
	Univers Apex Protector Post, 15 mm	AR-9200-25S	
	2	Univers II Trial Head, 40/17	AR-9240-17P
		Univers II Trial Head, 42/17	AR-9242-17P
		Univers II Trial Head, 44/17	AR-9244-19P
Univers II Trial Head, 44/19		AR-9244-19P	
Univers II Trial Head, 46/18		AR-9246-18P	
Univers II Trial Head, 46/20		AR-9246-20P	
Univers II Trial Head, 48/19		AR-9248-19P	
Univers II Trial Head, 48/21		AR-9248-21P	
Univers II Trial Head, 50/19		AR-9250-19P	
Univers II Trial Head, 50/21		AR-9250-21P	
Univers II Trial Head, 52/20		AR-9250-20P	
Univers II Trial Head, 52/22		AR-9252-22P	
Univers II Trial Head, 54/21		AR-9254-21P	
Univers II Trial Head, 54/23		AR-9254-23P	
Univers II Trial Head, 56/22		AR-9256-22P	
Univers II Trial Head, 56/24		AR-9256-24P	
3		Univers II Driver for Trial Head	AR-9202-091P
4		Humeral Head Impactor	AR-9202-13

Label	Product Description	Item Number
5	Univers II Resection Protector TRL SFT, 40 mm	AR-9202-40SP
	Univers II Resection Protector, 40 mm	AR-9202-40TP
	Univers II Resection Protector TRL SFT, 45 mm	AR-9202-45SP
	Univers II Resection Protector, 45 mm	AR-9202-45TP
6	Univers II Trial Trunnion	AR-9202-27
7	Humeral Head Extractor	AR-9401-17
8	Univers II Trunnion Extractor	AR-9202-38P
9	Univers II Stem Extractor	AR-9202-41P
10	Univers Slap Hammer	AR-9202-14

### Optional

Product Description	Item Number
Version Rod Bracket	AR-9231-20
Intramedullary Humeral Cutting Guide	AR-9401-14



## Univers VaultLock® Glenoid System



### Fluted Central Peg

- Immediate fixation
- OR efficiency

### Anatomic Backside Radius of Curvature (ROC)

- Matches glenoid poly to glenoid anatomy
- Subchondral bone-sparing reaming
- Simplified decision-making

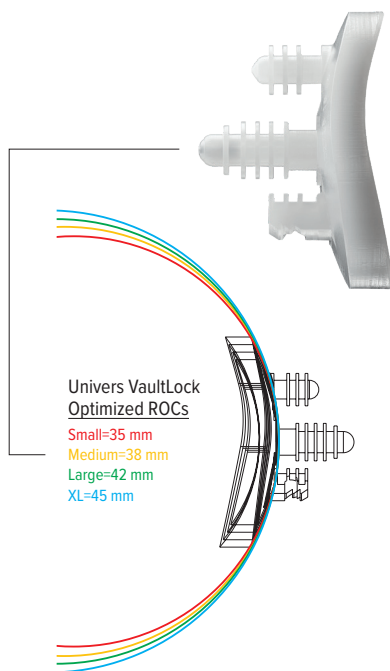

### Inferior Keel

- Decreased cortical penetration compared to inferior pegs
- Multiple fixation features, including reverse barbs, flutes, and central cement fenestration

### Superior Peg

- Enhanced immediate fixation
- Self-pressurizing design

### Inline Configuration

- Combines all advantages of pegged and keeled implants, including stability and ease of preparation

### Implants

Product Description	Item Number
Univers VaultLock Glenoid, small	AR-9106-01
Univers VaultLock Glenoid, medium	AR-9106-02
Univers VaultLock Glenoid, large	AR-9106-03
Univers VaultLock Glenoid, extra large	AR-9106-04

### Disposables

Product Description	Item Number
DynaNite® Virtual Implant Positioning™ Glenoid Pin, nitinol, 2.8 mm	AR-5400N-400NS
Eclipse™ and Univers™ II Pin Set	AR-9207S

## Keeled Glenoid



### Cemented Glenoid Reconstruction

- Keel with dual fenestration for improved cement acceptance
- Reverse barbs on the keel for enhanced anchoring

### Implants

Product Description	Item Number
Keeled Glenoid, cemented, small	AR-9104-01
Keeled Glenoid, cemented, medium	AR-9104-02
Keeled Glenoid, cemented, large	AR-9104-03
Keeled Glenoid, cemented, extra large	AR-9104-04

## Univers VaultLock® and Keel Glenoid Instrument Set

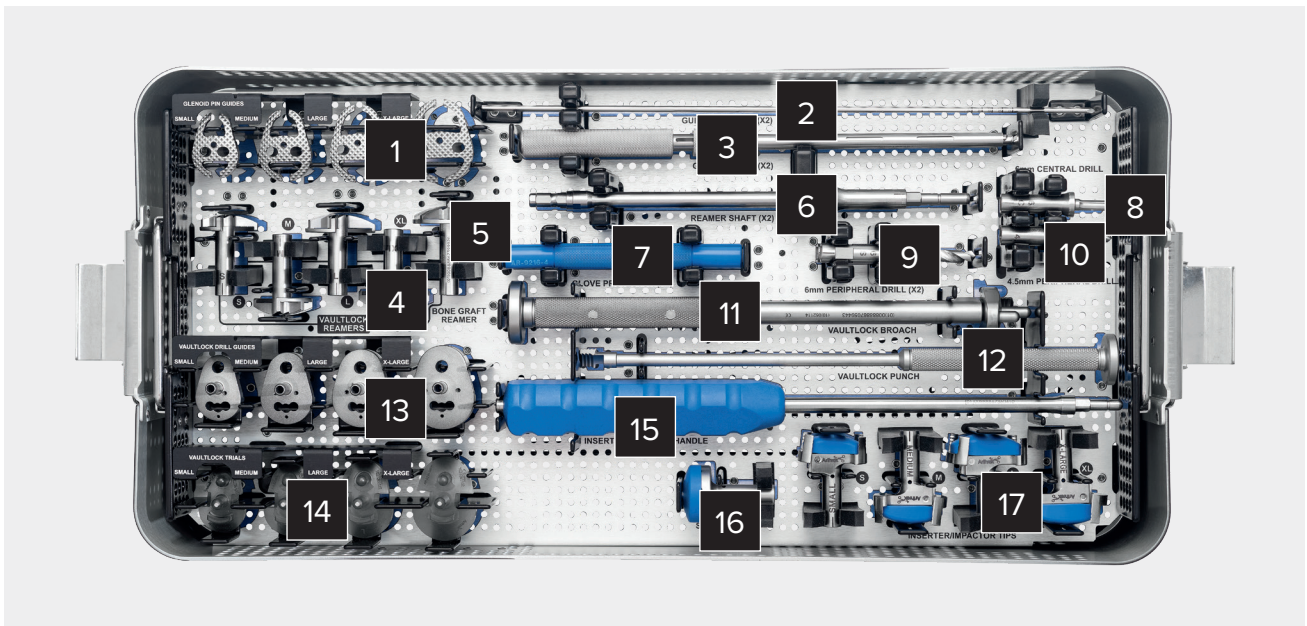

Univers VaultLock and Keel Glenoid Instrument Set - Top Tray (AR-9217VKS)

Label	Product Description	Item Number
1	Univers VaultLock/Keel Glenoid Pin Guide, quick connect, small Univers VaultLock/Keel Glenoid Pin Guide, quick connect, medium Univers VaultLock/Keel Glenoid Pin Guide, quick connect, large Univers VaultLock/Keel Glenoid Pin Guide, quick connect, extra large	AR-9215-VK-1 AR-9215-VK-2 AR-9215-VK-3 AR-9215-VK-4
2	Steinmann Pin, 2.8 mm	AR-9207
3	Quick-Connect Handle	AR-9215-1-03
4	Modular Univers VaultLock Reamer, small Modular Univers VaultLock Reamer, medium Modular Univers VaultLock Reamer, large Modular Univers VaultLock Reamer, extra large	AR-9228 AR-9229 AR-9230 AR-9231AG
5	Modular Bone Graft Reamer	AR-9229VLG
6	Quick-Connect Drive Shaft	AR-9617
7	Glove Protector	AR-9216-4
8	Modular Cannulated Central Drill, 6 mm	AR-9216AG
9	Modular Superior Drill, 6 mm	AR-9221AG
10	Modular Inferior Drill, 4.5 mm	AR-9239AG
11	Glenoid Broach	AR-9233
12	Glenoid Punch	AR-9234
13	Univers VaultLock Drill Guide, quick connect, small Univers VaultLock Drill Guide, quick connect, medium Univers VaultLock Drill Guide, quick connect, large Univers VaultLock Drill Guide, quick connect, extra large	AR-9231-VL-01 AR-9231-VL-02 AR-9231-VL-03 AR-9231-VL-04
14	Univers VaultLock Glenoid Trial, small Univers VaultLock Glenoid Trial, medium Univers VaultLock Glenoid Trial, large Univers VaultLock Glenoid Trial, extra large	AR-9236-01PP AR-9236-02PP AR-9236-03PP AR-9236-04PP
15	Glenoid Inserter/Impactor Handle	AR-9241-2
16	Secondary Glenoid Impactor	AR-9241-00
17	Glenoid Inserter/Impactor, small Glenoid Inserter/Impactor, medium Glenoid Inserter/Impactor, large Glenoid Inserter/Impactor, extra large	AR-9241-01 AR-9241-02 AR-9241-03 AR-9241-04

## Univers VaultLock® and Keel Glenoid Instrument Set (Cont.)

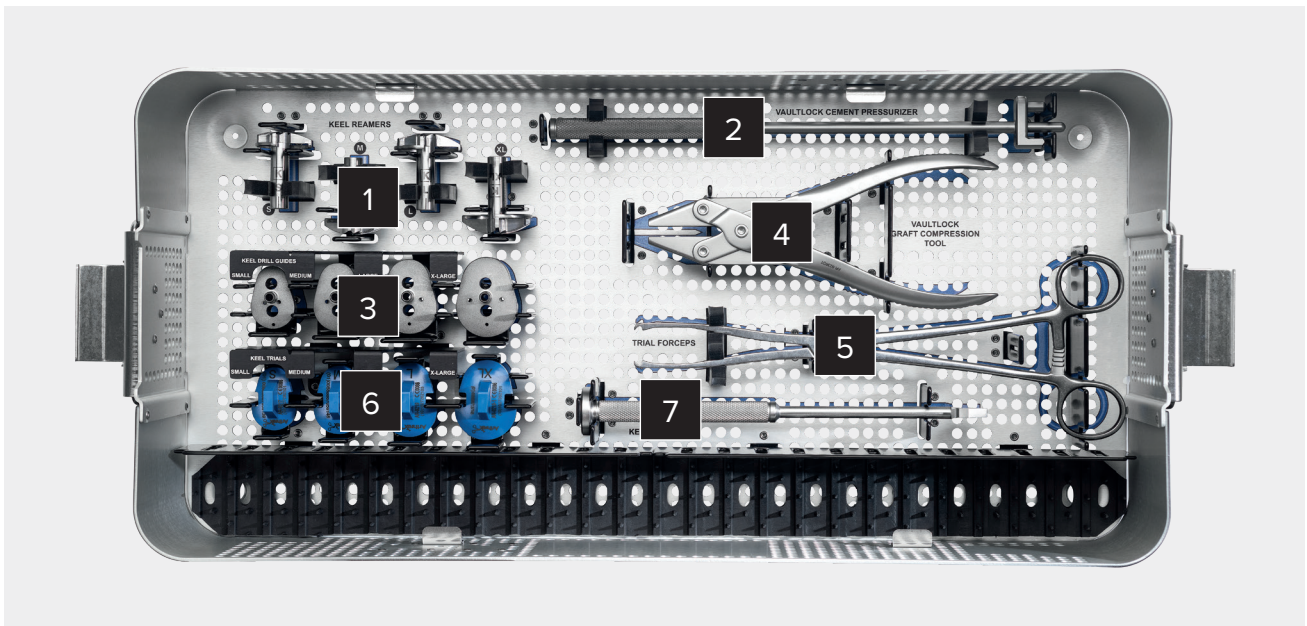

### Univers VaultLock and Keel Glenoid Instrument Set - Bottom Tray (AR-9217VKS)

Label	Product Description	Item Number
1	Modular Nautilus Reamer, small Modular Nautilus Reamer, medium Modular Nautilus Reamer, large Modular Nautilus Reamer, extra large	AR-9228NRM AR-9229NRM AR-9230NRM AR-9231NRM
2	Cement Pressurizer	AR-9235
3	Keel Glenoid Drill Guide, quick connect, small Keel Glenoid Drill Guide, quick connect, medium Keel Glenoid Drill Guide, quick connect, large Keel Glenoid Drill Guide, quick connect, extra large	AR-9215-K-3 AR-9215-K-5 AR-9215-K-7 AR-9215-K-9
4	Graft Compression Tool	AR-9236GT
5	Glenoid Trial Forceps	AR-9238
6	Keel Glenoid Trial, small Keel Glenoid Trial, medium Keel Glenoid Trial, large Keel Glenoid Trial, extra large	AR-9217 AR-9217 AR-9219 AR-9219-1
7	Keel Glenoid Punch	AR-9214

## Univers VaultLock® Augmented Glenoid System



### Fluted Central Peg

- Immediate fixation
- OR efficiency

### Anatomic Backside Radius of Curvature (ROC)

- Matches glenoid poly to glenoid anatomy
- Subchondral bone-sparing reaming
- Simplified decision-making

### Superior Peg

- Enhanced immediate fixation
- Self-pressurizing design

### Inline Configuration

- Combines all advantages of pegged and keeled implants including stability and preparation ease

### Inferior Keel

- Decreased cortical penetration compared to inferior pegs
- Multiple fixation features, including reverse barbs, flutes, and central cement fenestration

### Augmented Sizes

- 15° and 25° half-wedge options available for bone preservation

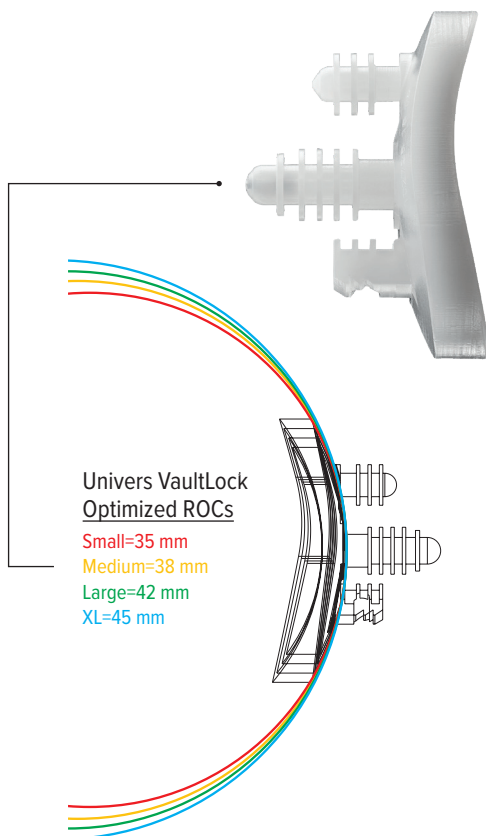

Univers VaultLock  
Optimized ROCs

Small=35 mm

Medium=38 mm

Large=42 mm

XL=45 mm

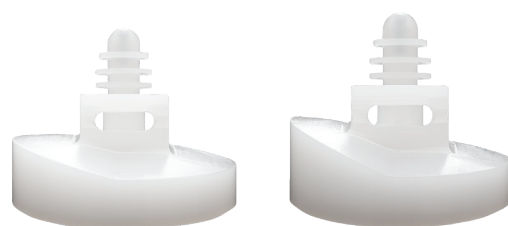

## Univers VaultLock® Augmented Glenoid System (Cont.)

### Implants

Product Description	Item Number
Augmented Univers VaultLock Glenoid, 15°, left, small	AR-9107-01-15L
Augmented Univers VaultLock Glenoid, 15°, left, medium	AR-9107-02-15L
Augmented Univers VaultLock Glenoid, 15°, left, large	AR-9107-03-15L
Augmented Univers VaultLock Glenoid, 15°, left, extra large	AR-9107-04-15L
Augmented Univers VaultLock Glenoid, 15°, right, small	AR-9107-01-15R
Augmented Univers VaultLock Glenoid, 15°, right, medium	AR-9107-02-15R
Augmented Univers VaultLock Glenoid, 15°, right, large	AR-9107-03-15R
Augmented Univers VaultLock Glenoid, 15°, right, extra large	AR-9107-04-15R
Augmented Univers VaultLock Glenoid, 25°, left, small	AR-9107-01-25L
Augmented Univers VaultLock Glenoid, 25°, left, medium	AR-9107-02-25L
Augmented Univers VaultLock Glenoid, 25°, left, large	AR-9107-03-25L
Augmented Univers VaultLock Glenoid, 25°, left, extra large	AR-9107-04-25L
Augmented Univers VaultLock Glenoid, 25°, right, small	AR-9107-01-25R
Augmented Univers VaultLock Glenoid, 25°, right, medium	AR-9107-02-25R
Augmented Univers VaultLock Glenoid, 25°, right, large	AR-9107-03-25R
Augmented Univers VaultLock Glenoid, 25°, right, extra large	AR-9107-04-25R

### Disposables

Product Description	Item Number
Angled Reamer, small	AR-9275-S
Angled Reamer, medium	AR-9275-M
Angled Reamer, large	AR-9275-L
DynaNite® Virtual Implant Positioning™ Glenoid Pin, nitinol, 2.8 mm	AR-5400-400NS
Eclipse™ and Univers™ II Pin Set	AR-9207S

## Univers VaultLock® Augmented Glenoid Instrument Set

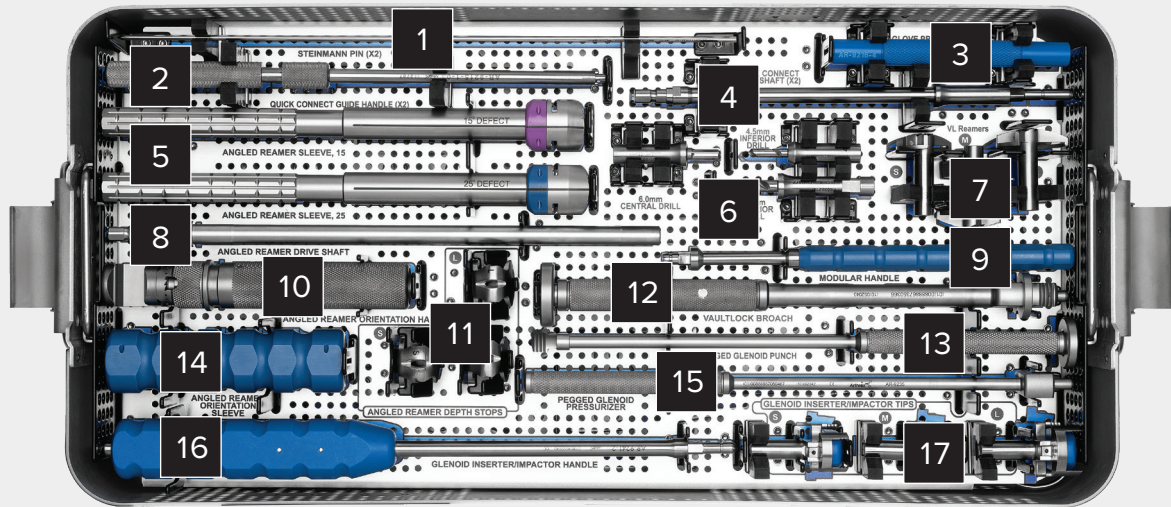

### Univers VaultLock Augmented Glenoid Instrument Set - Top Tray (AR-9217AVS)

Label	Product Description	Item Number
1	2.8 mm Steinmann Pin	AR-9207
2	Quick-Connect Handle	AR-9215-1-03
3	Glove Protector	AR-9216-4
4	Quick-Connect Drive Shaft	AR-9617
5	Angled Reamer Sleeve, 15° Angled Reamer Sleeve, 25°	AR-9297-15 AR-9297-25
6	6.0 mm Central Drill 4.5 mm Inferior Drill 6.0 mm Superior Drill	AR-9216AG AR-9239AG AR-9221AG
7	Modular Reamer, small Modular Reamer, medium Modular Reamer, large	AR-9228AG AR-9229AG AR-9230AG
8	Angled Reamer Drive Shaft	AR-9676
9	Modular Handle	AR-9595
10	Angled Reamer Orientation Handle	AR-9678
11	Angled Reamer Depth Stop, small Angled Reamer Depth Stop, medium Angled Reamer Depth Stop, large	AR-9298-S AR-9298-M AR-9298-L
12	Univers VaultLock Augmented Broach	AR-9233AG
13	Pegged Glenoid Punch	AR-9234
14	Angled Reamer Orientation Sleeve	AR-9679
15	Pegged Glenoid Pressurizer	AR-9235
16	Glenoid Inserter/Impactor Handle	AR-9241-2
17	Glenoid Inserter/Impactor, small Glenoid Inserter/Impactor, medium Glenoid Inserter/Impactor, large	AR-9241-01 AR-9241-02 AR-9241-03

## Univers VaultLock® Augmented Glenoid Instrument Set (Cont.)

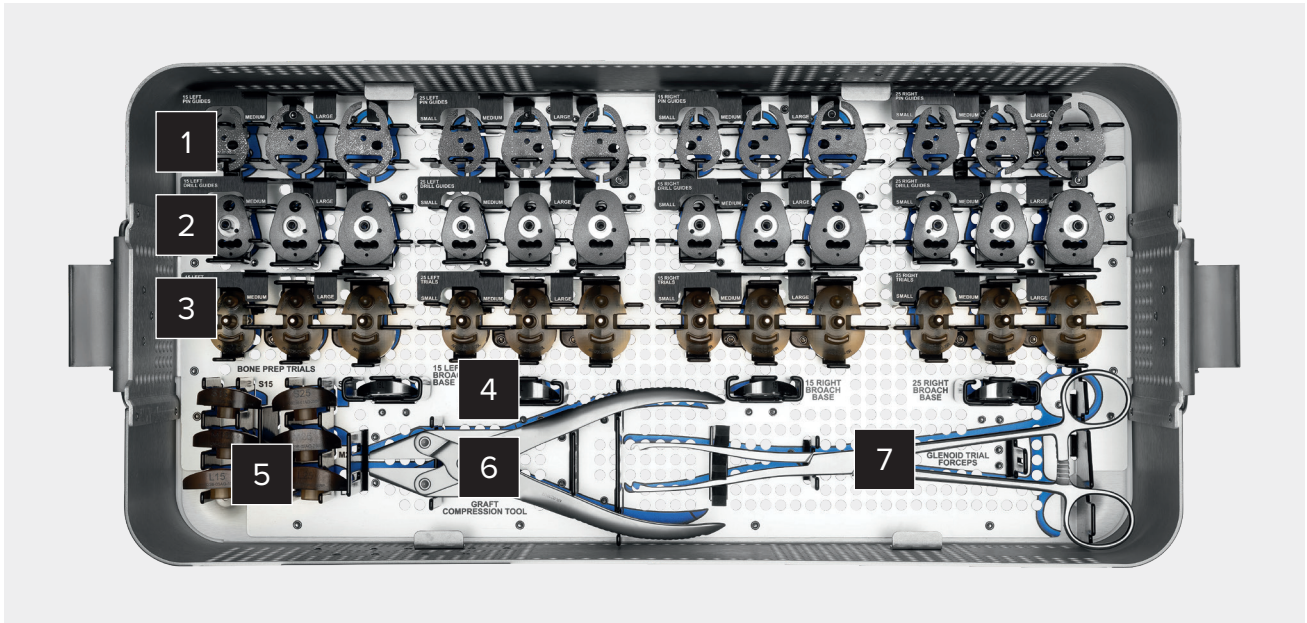

### Univers VaultLock Augmented Glenoid Instrument Set - Bottom Tray (AR-9217AVS)

Label	Product Description	Item Number
1	Augmented Univers VaultLock Pin Guide, 15° left (small, medium, large) Augmented Univers VaultLock Pin Guide, 25° left (small, medium, large) Augmented Univers VaultLock Pin Guide, 15° right (small, medium, large) Augmented Univers VaultLock Pin Guide, 25° right (small, medium, large)	AR-9215-2AG/4AG/6AG-15L AR-9215-2AG/4AG/6AG-25L AR-9215-2AG/4AG/6AG-15R AR-9215-2AG/4AG/6AG-25R
2	Augmented Univers VaultLock Drill Guide, 15° left (small, medium, large) Augmented Univers VaultLock Drill Guide, 25° left (small, medium, large) Augmented Univers VaultLock Drill Guide, 15° right (small, medium, large) Augmented Univers VaultLock Drill Guide, 25° right (small, medium, large)	AR-9231-01AG/02AG/03AG-15L AR-9231-01AG/02AG/03AG-25L AR-9231-01AG/02AG/03AG-15R AR-9231-01AG/02AG/03AG-25R
3	Augmented Univers VaultLock Trial, 15° left (small, medium, large) Augmented Univers VaultLock Trial, 25° left (small, medium, large) Augmented Univers VaultLock Trial, 15° right (small, medium, large) Augmented Univers VaultLock Trial, 25° right (small, medium, large)	AR-9236-01AG/02AG/03AG-15L AR-9236-01AG/02AG/03AG-25L AR-9236-01AG/02AG/03AG-15R AR-9236-01AG/02AG/03AG-25R
4	Augmented Univers VaultLock Broach Base, 15° left Augmented Univers VaultLock Broach Base, 25° left Augmented Univers VaultLock Broach Base, 15° right Augmented Univers VaultLock Broach Base, 25° right	AR-9233AG-15L AR-9233AG-25L AR-9233AG-15R AR-9233AG-25R
5	Augmented Univers VaultLock Bone Prep Trial, small (15°, 25°) Augmented Univers VaultLock Bone Prep Trial, medium (15°, 25°) Augmented Univers VaultLock Bone Prep Trial, large (15°, 25°)	AR-9236-01AG-15BP/25BP AR-9236-02AG-15BP/25BP AR-9236-03AG-15BP/25BP
6	Graft Compression Tool	AR-9236GT
7	Glenoid Trial Forceps	AR-9238



## Univers VaultLock® Augmented Glenoid XL Instrument Set

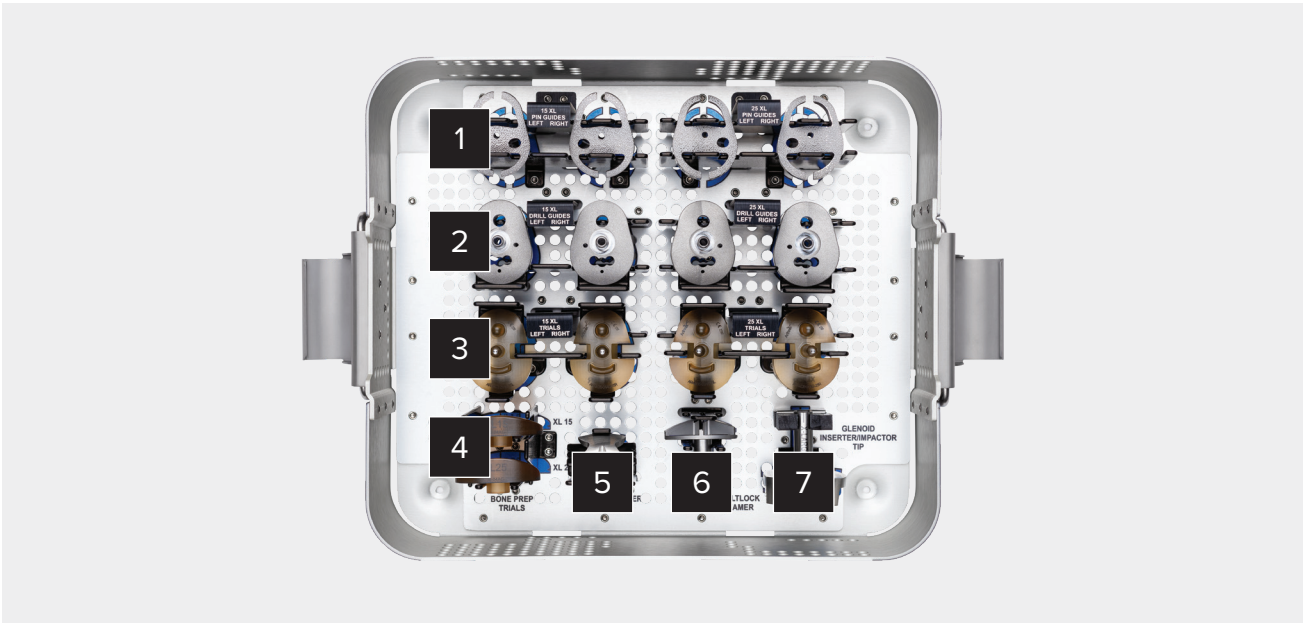

### Univers VaultLock Augmented Glenoid XL Instrument Set (AR-9217AVXLS)

Label	Product Description	Item Number
1	Augmented Univers VaultLock Pin Guide, x-large, 15° left	AR-9215-8AG-15L
	Augmented Univers VaultLock Pin Guide, x-large, 15° right	AR-9215-8AG-15R
	Augmented Univers VaultLock Pin Guide, x-large, 25° left	AR-9215-8AG-25L
	Augmented Univers VaultLock Pin Guide, x-large, 25° right	AR-9215-8AG-25R
2	Augmented Univers VaultLock Drill Guide, x-large, 15° left	AR-9231-04AG-15L
	Augmented Univers VaultLock Drill Guide, x-large, 15° right	AR-9231-04AG-15R
	Augmented Univers VaultLock Drill Guide, x-large, 25° left	AR-9231-04AG-25L
	Augmented Univers VaultLock Drill Guide, x-large, 25° right	AR-9231-04AG-25R
3	Augmented Univers VaultLock Trial, x-large, 15° left	AR-9236-04AG-15L
	Augmented Univers VaultLock Trial, x-large, 15° right	AR-9236-04AG-15R
	Augmented Univers VaultLock Trial, x-large, 25° left	AR-9236-04AG-25L
	Augmented Univers VaultLock Trial, x-large, 25° right	AR-9236-04AG-25R
4	Bone Prep Trial, x-large, 15°	AR-9236-04AG-15BP
	Bone Prep Trial, x-large, 25°	AR-9236-04AG-25BP
5	Angled Reamer Depth Stop, x-large	AR-9298-XL
6	Modular Reamer, x-large	AR-9231AG
7	Glenoid Inserter/Impactor, x-large	AR-9241-04

## Universal Glenoid™ Convertible Baseplate

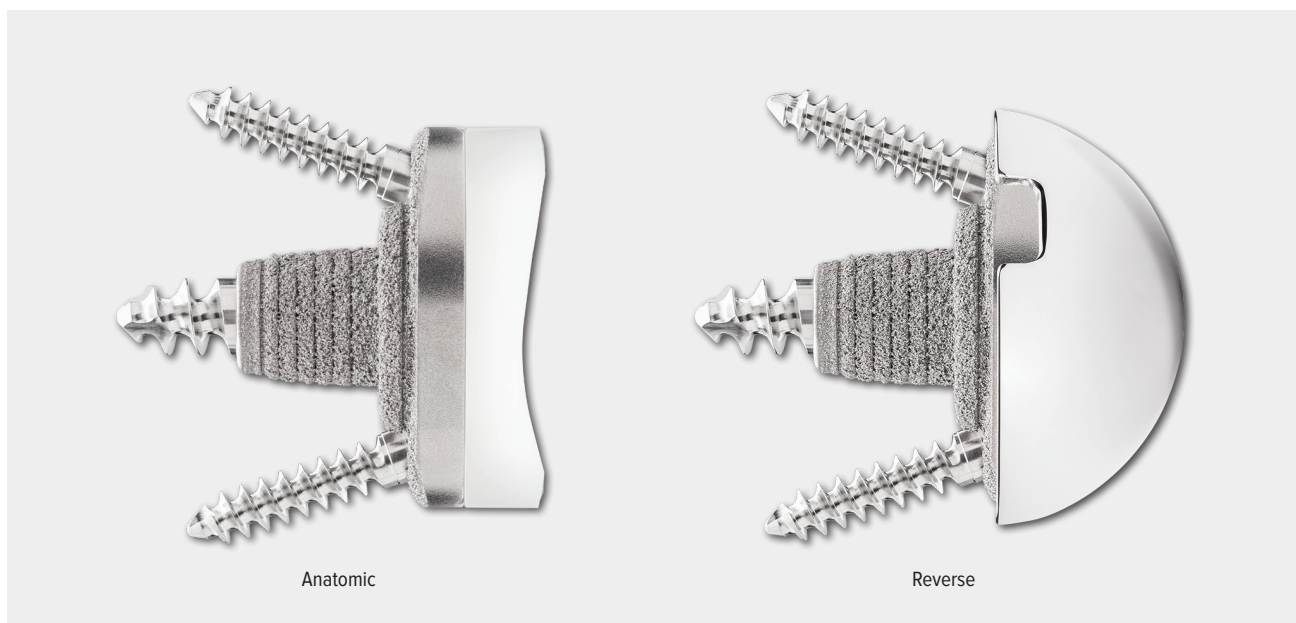

### Convertible Cementless Glenoid Reconstruction

- Baseplate may be combined with an anatomic polyethylene inlay for the advantages of anatomic reconstruction with the stability of screw fixation
- With the addition of a glenosphere to an existing baseplate, anatomic reconstructions can be conveniently converted to a reverse prosthesis
- Facilitates 0°-20° of version correction possibilities

### Implants

Product Description	Item Number
Universal Glenoid Baseplate, small	AR-9120-01PC
Universal Glenoid Baseplate, medium	AR-9120-02PC
Universal Glenoid Baseplate, large	AR-9120-03PC
Universal Glenoid Inlay, small	AR-9121-01
Universal Glenoid Inlay, medium	AR-9121-02
Universal Glenoid Inlay, large	AR-9121-03
Universal Glenoid Inlay, small PLUS	AR-9121-04
Universal Glenoid Inlay, medium PLUS	AR-9121-05
Universal Glenoid Inlay, large PLUS	AR-9121-06
Universal Glenoid Glenosphere, 42	AR-9504L
Universal Glenoid Glenosphere, 42+4 LAT	AR-9504L-04
Universal Glenoid Glenosphere, 42+2.5 INF	AR-9504M-02
Universal Glenoid Glenosphere, 39	AR-9504M
Universal Glenoid Glenosphere, 39+4 LAT	AR-9504M-04
Universal Glenoid Glenosphere, 39+2.5 INF	AR-9504S-02
Universal Glenoid Glenosphere, 36	AR-9504S
Universal Glenoid Glenosphere, 36+4 LAT	AR-9504S-04
Universal Glenoid Glenosphere, 36+2.5 INF	AR-9504S-INF
Universal Glenoid Peripheral Locking Screw, 24 mm	AR-9145-24
Universal Glenoid Peripheral Locking Screw, 30 mm	AR-9145-30
Universal Glenoid Peripheral Locking Screw, 36 mm	AR-9145-36
Universal Glenoid Peripheral Locking Screw, 42 mm	AR-9145-42
Universal Glenoid Peripheral Locking Screw, 48 mm	AR-9145-48
Universal Glenoid Central Screw, 15 mm	AR-9165-15
Universal Glenoid Central Screw, 20 mm	AR-9165-20
Universal Glenoid Central Screw, 25 mm	AR-9165-25

Product Description	Item Number
Univers Revers™ Peripheral Screw, nonlocking, 4.5 mm × 24 mm	AR-9145-24NL
Univers Revers Peripheral Screw, nonlocking, 4.5 mm × 30 mm	AR-9145-30NL
Univers Revers Peripheral Screw, nonlocking, 4.5 mm × 36 mm	AR-9145-36NL
Univers Revers Peripheral Screw, nonlocking, 4.5 mm × 42 mm	AR-9145-42NL
Univers Revers Peripheral Screw, nonlocking, 4.5 mm × 48 mm	AR-9145-48NL
Univers Revers Central Screw, nonlocking, 6.5 mm × 15 mm	AR-9165-15NL
Univers Revers Central Screw, nonlocking, 6.5 mm × 20 mm	AR-9165-20NL
Univers Revers Central Screw, nonlocking, 6.5 mm × 25 mm	AR-9165-25NL

## Universal Glenoid™ Instrument Set

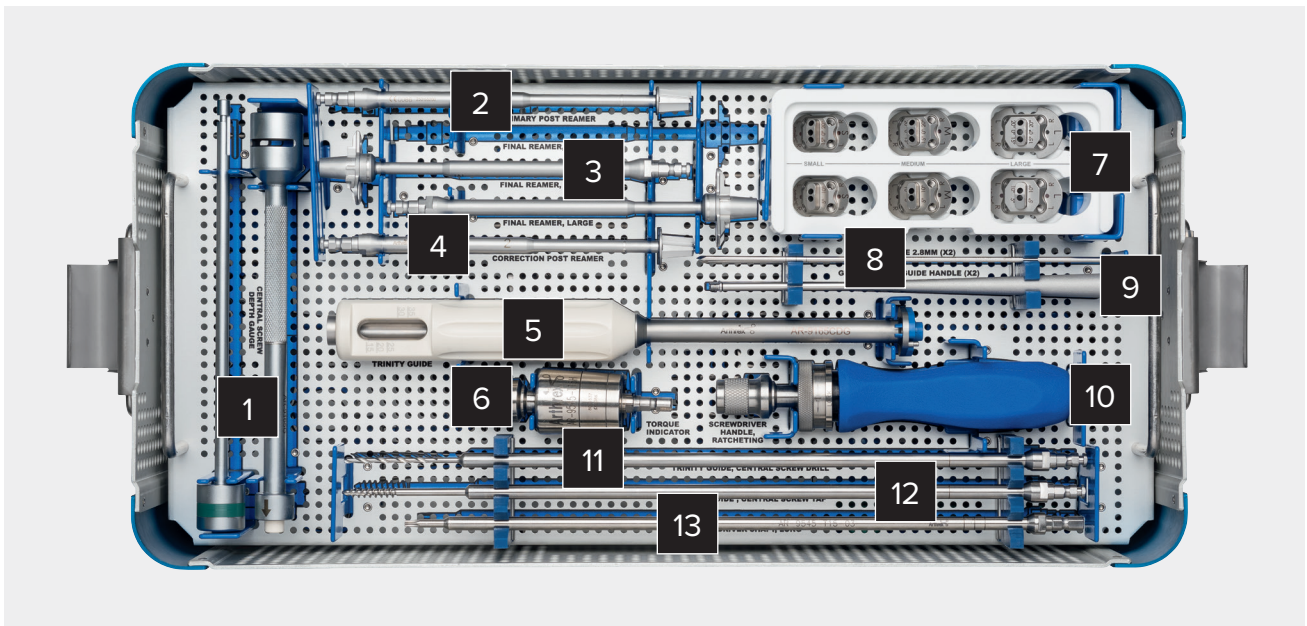

### Universal Glenoid Instrument Set - Top Tray (AR-9501GS)

Label	Product Description	Item Number
1	Central Screw Depth Gauge	AR-9165G
2	Primary Post Reamer	AR-9126RP
3	Final Reamer, small Final Reamer, medium Final Reamer, large	AR-9126-01 AR-9126-02 AR-9126-03
4	Correction Post Reamer	AR-9126RC
5	Universal Glenoid Baseplate Impactor (Trinity Guide)	AR-9165CDG
6	Torque Indicating Adapter	AR-9545-T15H
7	Glenoid Drill Guides, small Glenoid Drill Guides, medium Glenoid Drill Guides, large	AR-9125-1/AR-9125-10 AR-9125-2/AR-9125-20 AR-9125-3/AR-9125-30
8	2.8 mm Guide Pin, qty. 2	AR-9165K
9	Glenoid Drill Guide Handle	AR-9125H
10	Ratcheting Modular Handle	AR-1999HH
11	Baseplate Impactor Drill, 2.8 mm	AR-9165DDG
12	Baseplate Impactor Central Screw Tap	AR-9165TDG
13	T15 Driver Shaft, long	AR-9545-T15-03

## Universal Glenoid™ Instrument Set (Cont.)

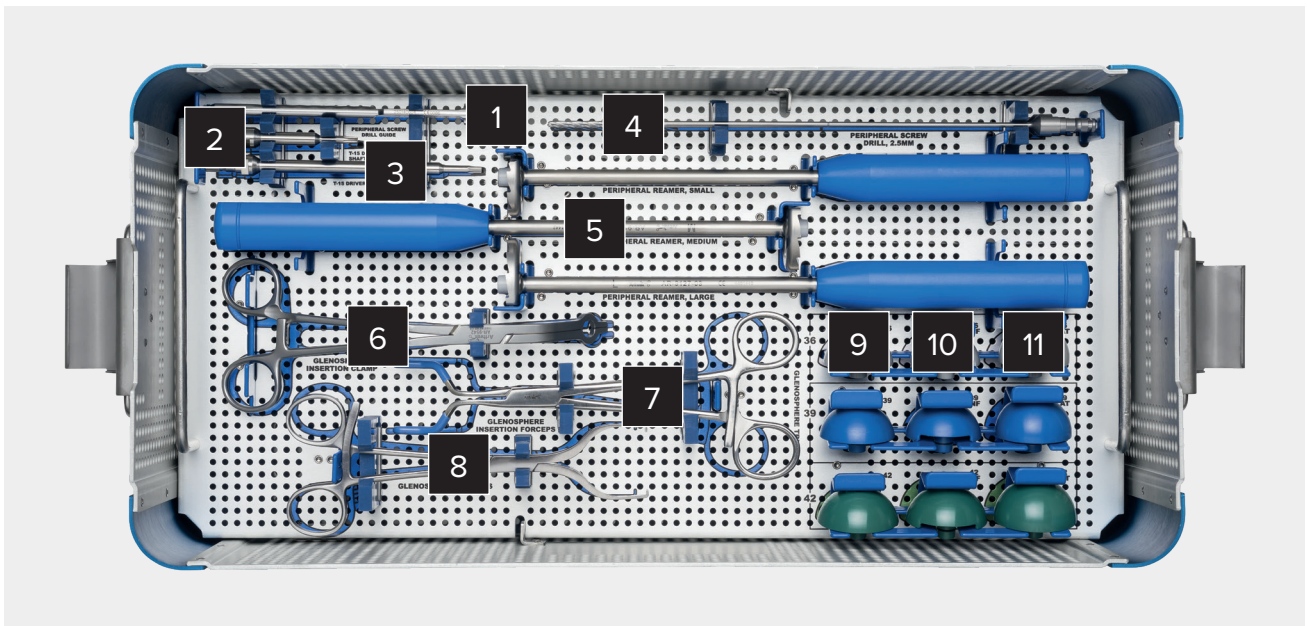

### Universal Glenoid Instrument Set - Middle Tray (AR-9501GS)

Label	Product Description	Item Number
1	Peripheral Screw Drill Guide	AR-9145DG
2	T15 Driver Shaft, short	AR-9545-T15-01
3	T15 Driver Shaft, medium	AR-9545-T15-02
4	Peripheral Screw Drill, 2.5 mm	AR-9145K
5	Baseplate Coring Reamer, small Baseplate Coring Reamer, medium Baseplate Coring Reamer, large	AR-9127-01 AR-9127-02 AR-9127-03
6	Glenosphere Inserter	AR-9542
7	Glenoid Forceps	AR-9240
8	Glenosphere Forceps	AR-9544
9	Trial Glenospheres, 36 mm	AR-9540SM, AR-9540SM-INF, AR-9540SM-04
10	Trial Glenospheres, 39 mm	AR-9540MD, AR-9540SM-02, AR-9540MD-04
11	Trial Glenospheres, 42 mm	AR-9540LG, AR-9540MD-02, AR-9540LG-04

## Universal Glenoid™ Instrument Set (Cont.)

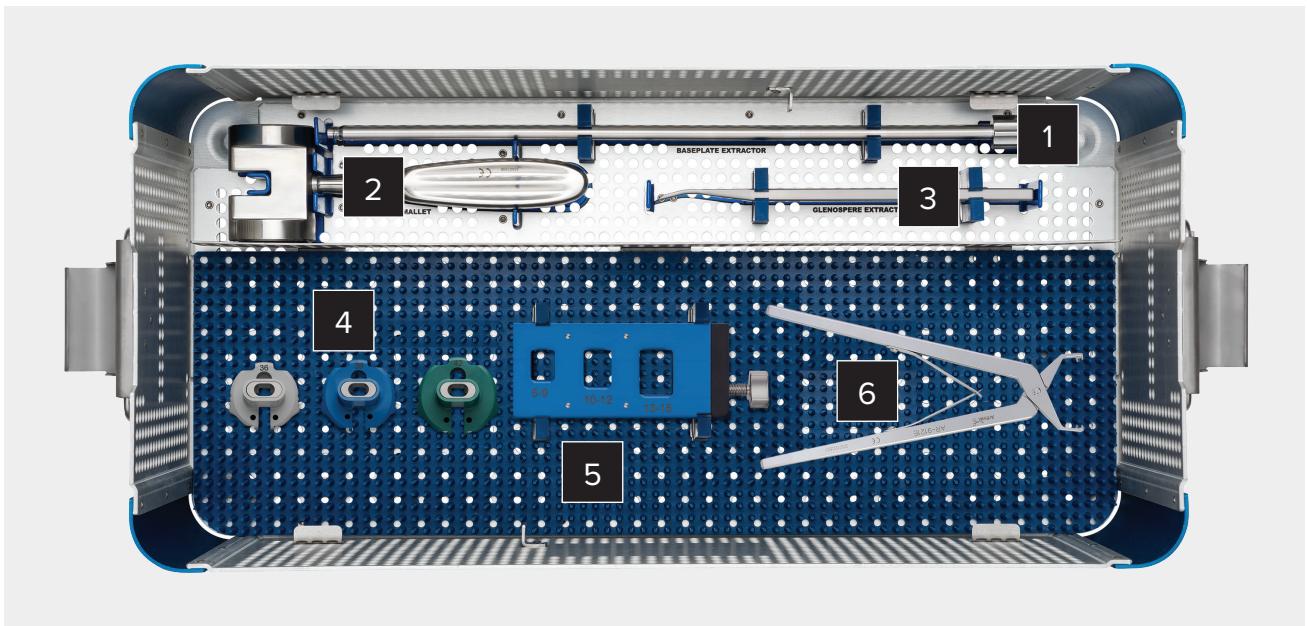

### Universal Glenoid Instrument Set - Bottom Tray (AR-9501GS)

Label	Product Description	Item Number
1	Baseplate Extractor	AR-9120E
2	Slotted Mallet	AR-9231-21
3	Glenosphere Extractor/Chisel	AR-9123GE
4	Cup Alignment Guides	AR-9532-36/39/42
5	Revers Humeral Assembly Station	AR-9532
6	Universal Glenoid Inlay Extractor	AR-9121E

## Univers Revers™ Total Shoulder System

### Humeral Stems

- Rectangular proximal filling stem based on anatomic geometry of Univers™ II total shoulder system
- Calcium phosphate (HA or CaP)-coated proximal stem
- 1 mm size increments for optimized press-fit
- Traditional-length stems from 95 mm to 147 mm
- Univers Revers Apex stems from 60 mm to 65 mm
- 135° and 155° inclination angles in one universal stem body



### SutureCups, Liners, and Spacers

- 33 mm, 36 mm, 39 mm, and 42 mm options
- Suture holes for tuberosity and rotator cuff attachment
- Calcium phosphate (CaP)-coated cup
- Centered and offset options for bone preservation and anatomic placement
- 2 polyethylene liners and 4 titanium spacer thicknesses for optional soft-tissue balancing
- Standard and constrained liner options
- Combination liners allow upsizing the glenosphere by one size in respect to the humeral cup
- Adapters available for revision to anatomic hemi-shoulder replacement with cuff arthropathy (CA) humeral head



## Univers Revers™ Total Shoulder System (Cont.)

### Implants

Product Description	Item Number
<b>Stems</b>	
Univers Revers Stem, size 4/33, monoblock 135°	AR-9501-04-135P
Univers Revers Stem, size 5	AR-9501-05P
Univers Revers Stem, size 6	AR-9501-06P
Univers Revers Stem, size 7	AR-9501-07P
Univers Revers Stem, size 8	AR-9501-08P
Univers Revers Stem, size 9	AR-9501-09P
Univers Revers Stem, size 10	AR-9501-10P
Univers Revers Stem, size 11	AR-9501-11P
Univers Revers Stem, size 12	AR-9501-12P
Univers Revers Stem, size 13	AR-9501-13P
Univers Revers Stem, size 14	AR-9501-14P
Univers Revers Stem, size 15	AR-9501-15P
Univers Revers Stem, size 6, revision (180 mm)	AR-9501-06RCPC
Univers Revers Stem, size 9, revision (180 mm)	AR-9501-09RCPC
Univers Revers Stem, size 12, revision (180 mm)	AR-9501-12RCPC
Univers Revers Apex Stem, 6	AR-9501-06S
Univers Revers Apex Stem, 7	AR-9501-07S
Univers Revers Apex Stem, 8	AR-9501-08S
Univers Revers Apex Stem, 9	AR-9501-09S
Univers Revers Apex Stem, 10	AR-9501-10S
Univers Revers Apex Stem, 11	AR-9501-11S
Univers Revers Apex Stem, 12	AR-9501-12S
Univers Revers Apex Stem, 13	AR-9501-13S
Univers Revers Apex Stem, 14	AR-9501-14S
Univers Revers Apex Stem, 15	AR-9501-15S
<b>SutureCups</b>	
Univers Revers SutureCup, 33 (neutral)	AR-9502F-33CPC
Univers Revers SutureCup, 33 (+2 mm left)	AR-9502F-33LCPC
Univers Revers SutureCup, 33 (+2 mm right)	AR-9502F-33RCPC
Univers Revers SutureCup, 36 (neutral)	AR-9502F-36CPC
Univers Revers SutureCup, 36 (+2 mm left)	AR-9502F-36LCPC
Univers Revers SutureCup, 36 (+2 mm right)	AR-9502F-36RCPC
Univers Revers SutureCup, 39 (neutral)	AR-9502F-39CPC
Univers Revers SutureCup, 39 (+2 mm left)	AR-9502F-39LCPC
Univers Revers SutureCup, 39 (+2 mm right)	AR-9502F-39RCPC
Univers Revers SutureCup, 42 (neutral)	AR-9502F-42CPC
Univers Revers SutureCup, 42 (+2 mm left)	AR-9502F-42LCPC
Univers Revers SutureCup, 42 (+2 mm right)	AR-9502F-42RCPC
<b>Humeral Inserts</b>	
Humeral Insert, 33+3 mm	AR-9503XS-03
Humeral Insert, 33+6 mm	AR-9503XS-06
Humeral Insert, 33+3 mm, constrained	AR-9503XS-03C
Humeral Insert, 33+6 mm, constrained	AR-9503XS-06C
Humeral Insert, 42+3 mm	AR-9503L-03
Humeral Insert, 42+3 mm, constrained	AR-9503L-03C
Humeral Insert, 42+6 mm	AR-9503L-06
Humeral Insert, 42+6 mm, constrained	AR-9503L-06C
Humeral Insert, 39+3 mm	AR-9503M-03
Humeral Insert, 39+3 mm, constrained	AR-9503M-03C
Humeral Insert, 39+6 mm	AR-9503M-06
Humeral Insert, 39+6 mm, constrained	AR-9503M-06C

Product Description	Item Number
Humeral Insert, 36+3 mm	AR-9503S-03
Humeral Insert, 36+3 mm, constrained	AR-9503S-03C
Humeral Insert, 36+6 mm	AR-9503S-06
Humeral Insert, 36+6 mm, constrained	AR-9503S-06C
<b>Humeral Spacers</b>	
Humeral Spacer, 33+6 mm	AR-9504-06
Humeral Spacer, 33+9 mm	AR-9504-09
Humeral Spacer, 33+12 mm	AR-9504-12
Humeral Spacer, 33+15 mm	AR-9504-15
Humeral Spacer, 39+6 mm	AR-9505-06
Humeral Spacer, 39+9 mm	AR-9505-09
Humeral Spacer, 39+12 mm	AR-9505-12
Humeral Spacer, 39+15 mm	AR-9505-15
Humeral Spacer, 42+6 mm	AR-9550-06
Humeral Spacer, 42+9 mm	AR-9550-09
Humeral Spacer, 42+12 mm	AR-9550-12
Humeral Spacer, 42+15 mm	AR-9550-15
Humeral Spacer, 36+6 mm	AR-9555-06
Humeral Spacer, 36+9 mm	AR-9555-09
Humeral Spacer, 36+12 mm	AR-9555-12
Humeral Spacer, 36+15 mm	AR-9555-15
<b>Combination Humeral Inserts</b>	
Combination Humeral Insert, 33+3/36	AR-9503-3336-3
Combination Humeral Insert, 33+6/36	AR-9503-3336-6
Combination Humeral Insert, 33+3C/36, constrained	AR-9503-3336-3C
Combination Humeral Insert, 33+6C/36, constrained	AR-9503-3336-6C
Combination Humeral Insert, 36+3/33	AR-9503-3633-3
Combination Humeral Insert, 36+6/33	AR-9503-3633-6
Combination Humeral Insert, 36+3/33, constrained	AR-9503-3633-3C
Combination Humeral Insert, 36+6/33, constrained	AR-9503-3633-6C
Combination Humeral Insert, 36+3/39	AR-9503-3639-3
Combination Humeral Insert, 36+6/39	AR-9503-3639-6
Combination Humeral Insert, 36+3/39, constrained	AR-9503-3639-3C
Combination Humeral Insert, 36+6/39, constrained	AR-9503-3639-6C
Combination Humeral Insert, 39+3/42	AR-9503-3942-3
Combination Humeral Insert, 39+6/42	AR-9503-3942-6
Combination Humeral Insert, 39+3/42, constrained	AR-9503-3942-3C
Combination Humeral Insert, 39+6/42, constrained	AR-9503-3942-6C
Combination Humeral Insert, 42+3/45	AR-9503-4245-3
Combination Humeral Insert, 42+6/45	AR-9503-4245-6
Combination Humeral Insert, 42+3/45, constrained	AR-9503-4245-3C
Combination Humeral Insert, 42+6/45, constrained	AR-9503-4245-6C

## Univers Revers™ Apex Humeral Instrumentation Set

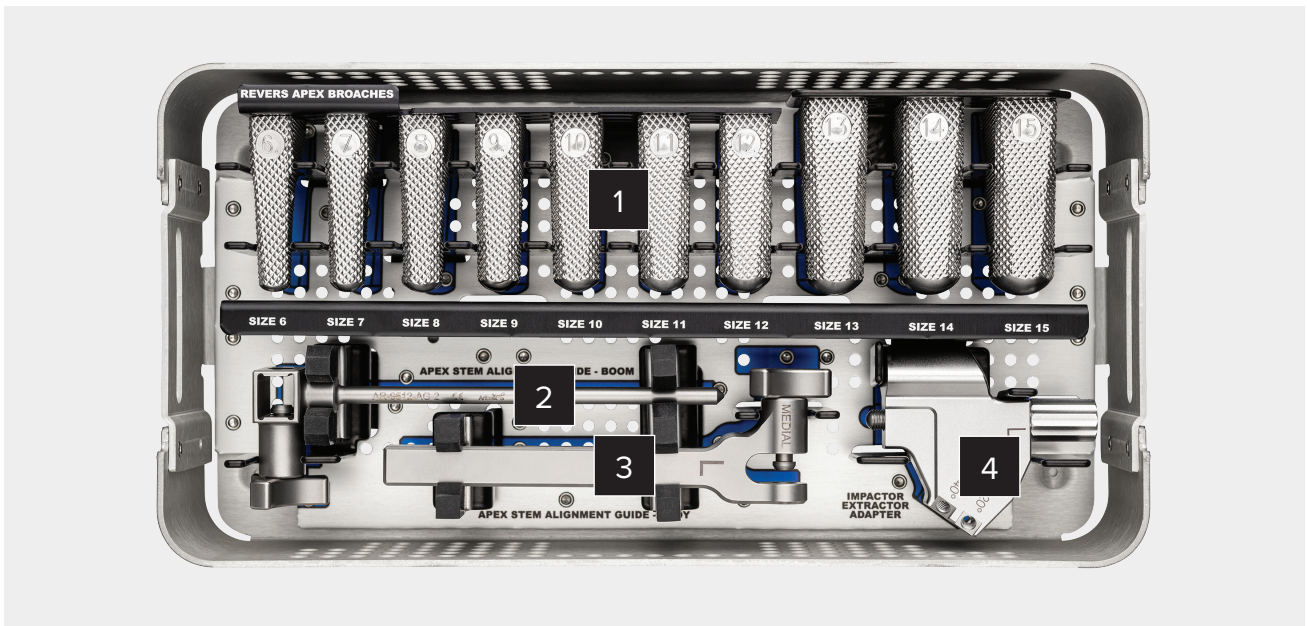

### Univers Revers Apex Humeral Instrumentation Set (AR-9501-RAB)

Label	Product Description	Item Number
1	Revers Apex Broach/Trial, size 6	AR-9510-06SM
	Revers Apex Broach/Trial, size 7	AR-9510-07SM
	Revers Apex Broach/Trial, size 8	AR-9510-08SM
	Revers Apex Broach/Trial, size 9	AR-9510-09SM
	Revers Apex Broach/Trial, size 10	AR-9510-10SM
	Revers Apex Broach/Trial, size 11	AR-9510-11SM
	Revers Apex Broach/Trial, size 12	AR-9510-12SM
	Revers Apex Broach/Trial, size 13	AR-9510-13SM
	Revers Apex Broach/Trial, size 14	AR-9510-14SM
	Revers Apex Broach/Trial, size 15	AR-9510-15SM
2	Univers Revers Humeral Alignment Guide Boom	AR-9512-AG-1
3	Univers Revers Humeral Alignment Guide Body	AR-9512-AG-2
4	Univers Revers Apex Impactor/Extractor	AR-9511-2



## Univers Revers™ Humeral Broach Instrumentation Set

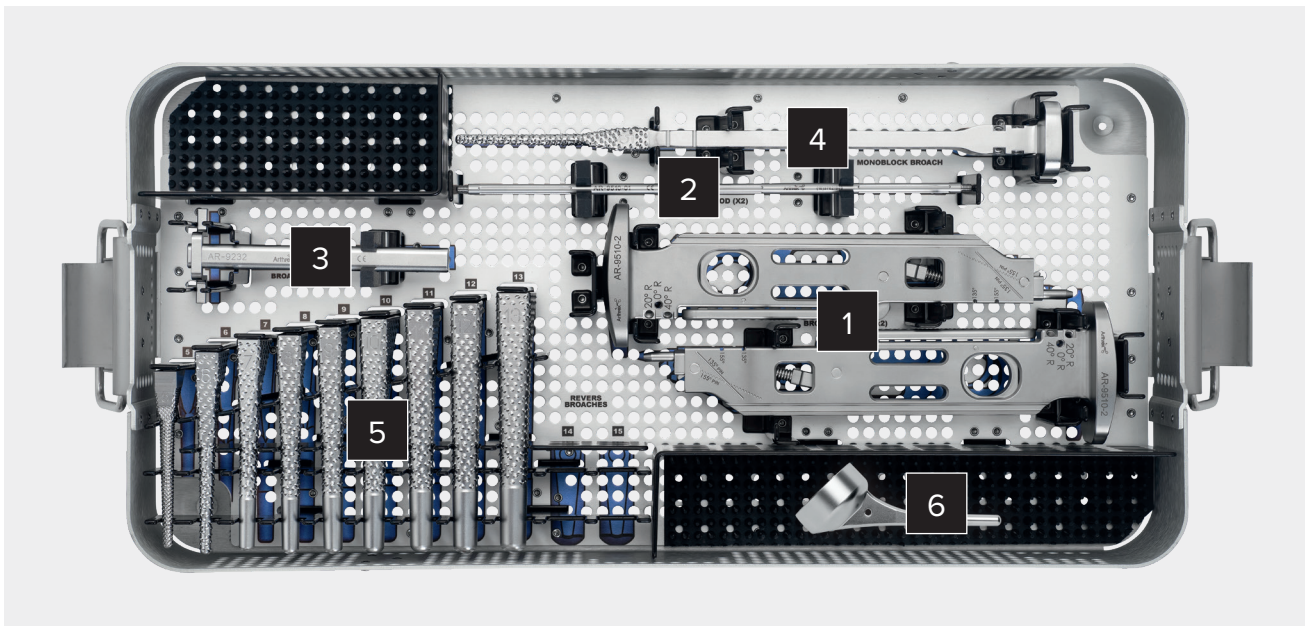

### Univers Revers Humeral Broach Instrumentation Set - Bottom Tray (AR-9501HBS)

Label	Product Description	Item Number
1	Lever-Lock Broach Handle	AR-9510-2
2	Version Rod	AR-9510-01
3	Humeral Broach Alignment Guide	AR-9232
4	Monoblock Broach, size 4/33	AR-9510-04M
5	Revers Humeral Broach, size 5 Revers Humeral Broach, size 6 Revers Humeral Broach, size 7 Revers Humeral Broach, size 8 Revers Humeral Broach, size 9 Revers Humeral Broach, size 10 Revers Humeral Broach, size 11 Revers Humeral Broach, size 12 Revers Humeral Broach, size 13	AR-9510-05MDM AR-9510-06M AR-9510-07M AR-9510-08M AR-9510-09M AR-9510-10M AR-9510-11M AR-9510-12M AR-9510-13M
6	Monoblock Stem Trial, size 4/33	AR-9523-04-135

## Univers Revers™ Humeral Instrument Set 1

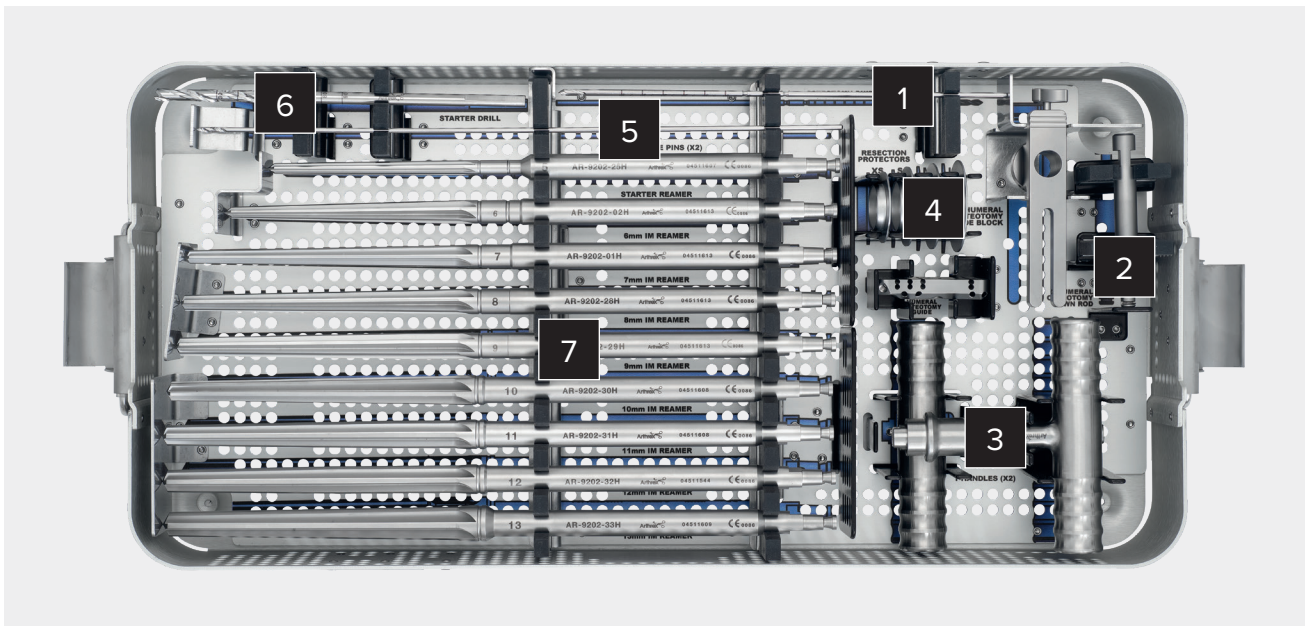

### Univers Revers Humeral Instrument Set 1 (AR-9501HS-1)

Label	Product Description	Item Number
1	Osteotomy Guide Pin	AR-13303-2.4
2	Humeral Resection Guide Assembly	AR-9507RGDP
3	Universal T-Handle	AR-9202-15H
4	Humeral Resection Protector, extra small Humeral Resection Protector, small Humeral Resection Protector, medium Humeral Resection Protector, large	AR-9509-XS AR-9509-S AR-9509-M AR-9509-L
5	2.4 mm Guidewires	AR-1250L
6	Cannulated Drill, 6 mm	AR-1206L
7	IM Reamer, 5 mm IM Reamer, 6 mm IM Reamer, 7 mm IM Reamer, 8 mm IM Reamer, 9 mm IM Reamer, 10 mm IM Reamer, 11 mm IM Reamer, 12 mm IM Reamer, 13 mm	AR-9202-25H AR-9202-02H AR-9202-01H AR-9202-28H AR-9202-29H AR-9202-30H AR-9202-31H AR-9202-32H AR-9202-33H

## Univers Revers™ Humeral Instrument Set 2

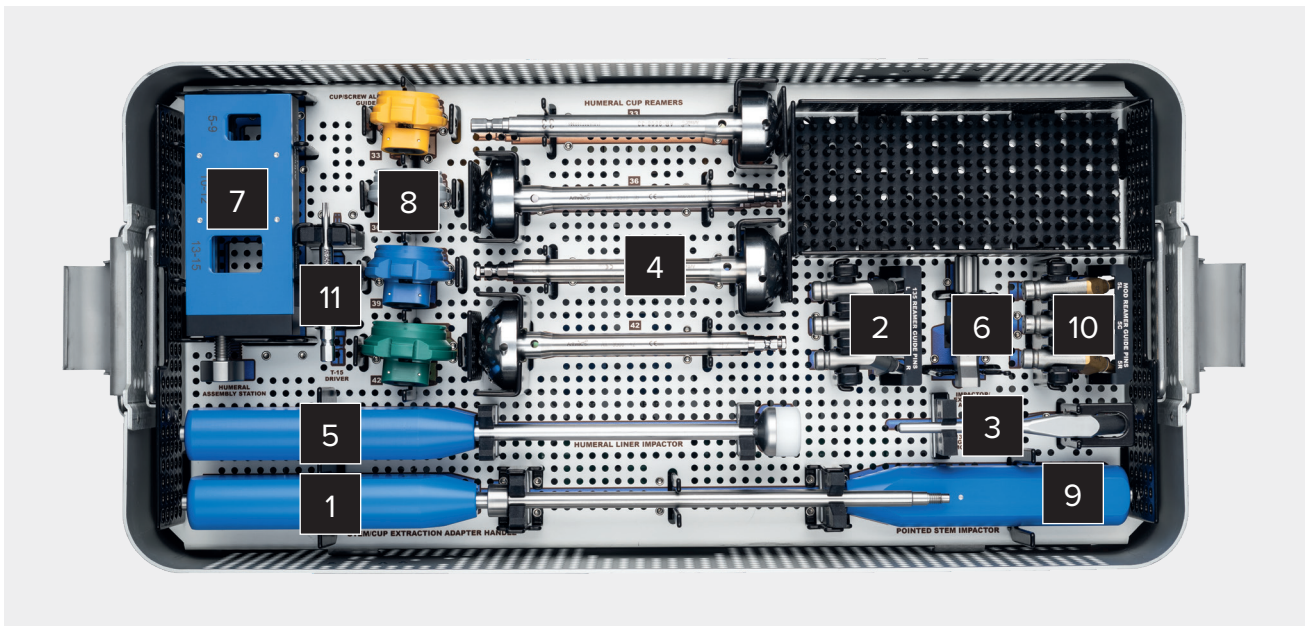

### Univers Revers Humeral Instrument Set 2 - Top Tray (AR-9501HS-2)

Label	Product Description	Item Number
1	Stem/Cup Impactor/Extractor Handle	AR-9512
2	Univers Modular Reamer Pins, 135°	AR-9510RG-C/R/L
3	Reamer/Guide, size 4/33, 135°	AR-9510-04-135
4	Humeral Cup Reamer, 33 mm Humeral Cup Reamer, 36 mm Humeral Cup Reamer, 39 mm Humeral Cup Reamer, 42 mm	AR-9508-33 AR-9508-36 AR-9508-39 AR-9508-42
5	Liner/Glenosphere Impactor	AR-9531
6	Humeral Impactor/Extractor Adapter	AR-9511-2
7	Assembly Stand	AR-9532
8	Cup Screw Alignment Guide, 33 mm Cup Screw Alignment Guide, 36 mm Cup Screw Alignment Guide, 39 mm Cup Screw Alignment Guide, 42 mm	AR-9532-33 AR-9532-36 AR-9532-39 AR-9532-42
9	Pointed Impactor	AR-9202-09
10	Univers Revers Reamer Guides, size 5	AR-9510RG-5C/5R/5L
11	T15 Driver Shaft, short	AR-9545-T15-01

## Univers Revers™ Humeral Instrument Set 2 (Cont.)

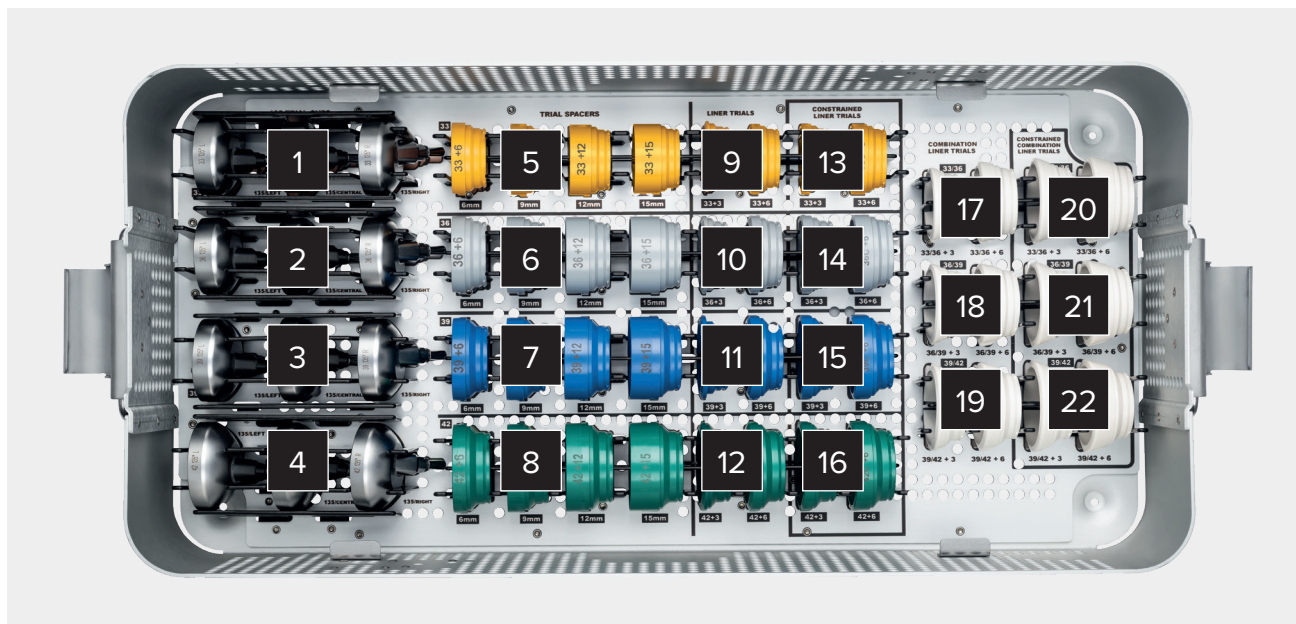

### Univers Revers Humeral Instrument Set 2 - Bottom Tray (AR-9501HS-2)

Label	Product Description	Item Number
1	135° Trial Cups, 33 mm	AR-9523-135/135R/135L
2	135° Trial Cups, 36 mm	AR-9522-135/135R/135L
3	135° Trial Cups, 39 mm	AR-9520-135/135R/135L
4	135° Trial Cups, 42 mm	AR-9521-135/135R/135L
5	Trial Spacers, 33 mm	AR-9554-06/09/12/15
6	Trial Spacers, 36 mm	AR-9551-06/09/12/15
7	Trial Spacers, 39 mm	AR-9552-06/09/12/15
8	Trial Spacers, 42 mm	AR-9553-06/09/12/15
9	Trial Liners, 33 mm	AR-9530XS-03/06
10	Trial Liners, 36 mm	AR-9530S-03/06
11	Trial Liners, 39 mm	AR-9530M-03/06
12	Trial Liners, 42 mm	AR-9530L-03/06
13	Constrained Trial Liners, 33 mm	AR-9530XS-03C/06C
14	Constrained Trial Liners, 36 mm	AR-9530S-03C/06C
15	Constrained Trial Liners, 39 mm	AR-9530M-03C/06C
16	Constrained Trial Liners, 42 mm	AR-9530L-03C/06C
17	Combo Trial Liners, 33 mm/36 mm	AR-9603-3336-3/6
18	Combo Trial Liners, 36 mm/39 mm	AR-9603-3639-3/6
19	Combo Trial Liners, 39 mm/42 mm	AR-9603-3942-3/6
20	Constrained Combo Trial Liners, 33 mm/36 mm	AR-9603-3336-3C/6C
21	Constrained Combo Trial Liners, 36 mm/39 mm	AR-9603-3639-3C/6C
22	Constrained Combo Trial Liners, 39 mm/42 mm	AR-9603-3942-3C/6C

## Univers Revers™ CA Head and Adapter Trials

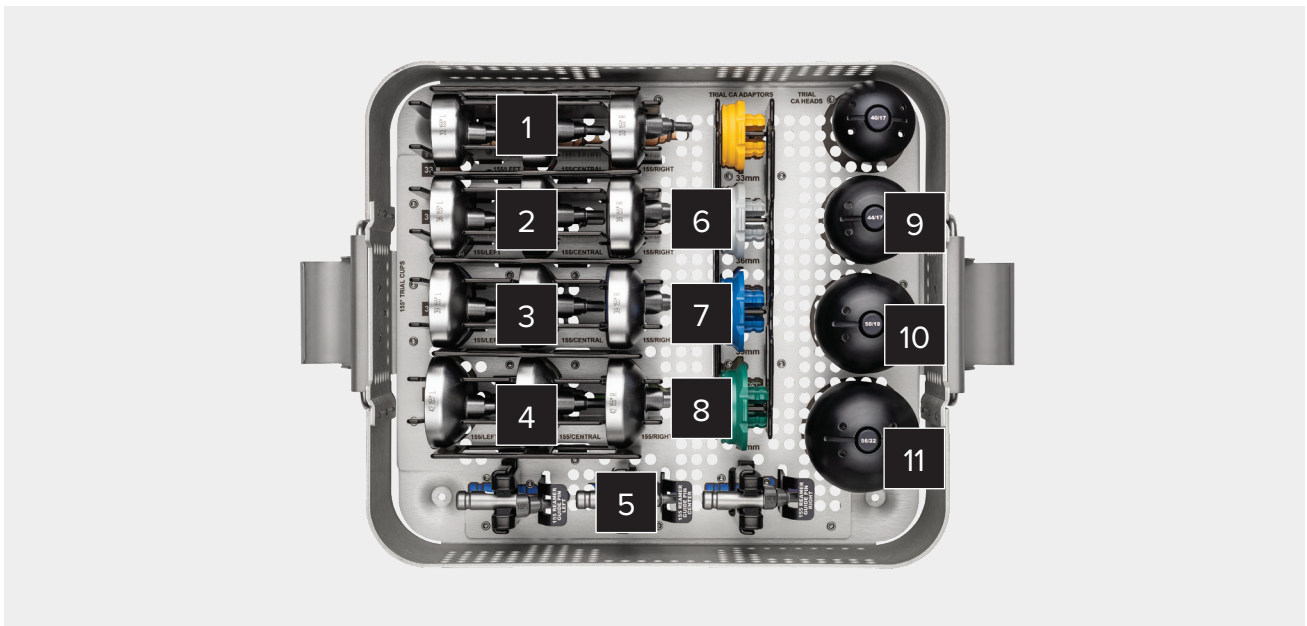

### Univers Revers CA Head and Adapter Trials (AR-9501H-CA155S)

Label	Product Description	Item Number
1	155° Trial Cups, 33 mm	AR-9523-155/155R/155L
2	155° Trial Cups, 36 mm	AR-9522-155/155R/155L
3	155° Trial Cups, 39 mm	AR-9520-155/155R/155L
4	155° Trial Cups, 42 mm	AR-9521-155/155R/155L
5	Univers Modular Reamer Pins, 155°	AR-9511RG-C/R/L
6	Univers Revers CA Trial Adapter, 36 mm	AR-9522-36ARCAT
7	Univers Revers CA Trial Adapter, 39 mm	AR-9522-39ARCAT
8	Univers Revers CA Trial Adapter, 42 mm	AR-9522-42ARCAT
9	Univers Revers CA Trial Head, 44/17 mm	AR-9544-17RCAT
10	Univers Revers CA Trial Head, 50/19 mm	AR-9550-19RCAT
11	Univers Revers CA Trial Head, 56/22 mm	AR-9556-22RCAT

## Univers Revers™ CA Head and Adapter Trials (Cont.)

### Disposables

Product Description	Item Number
Univers Revers Sterile Pin Set	AR-9507S

### Optional Instruments

Product Description	Item Number
Humeral Resection Block, 135°/155° (superolateral)	AR-9507RGSL-1
Superolateral Version Guide Adapter	AR-9507RGSL-2
Univers Revers Reduction Tool	AR-9545
Superolateral Humeral Resection Instrument Set	AR-9507RGSL
Humeral Resection Block, 135°/155° (superolateral)	AR-9507RGSL-1
Superolateral Version Guide Adapter	AR-9507RGSL-2
Superolateral Version Downrod	AR-9507RGSL-3
Univers Revers Reduction Tool	AR-9545
Large Humeral (14/15 mm) Instrument Set	AR-9501LHS
IM Reamer, 14 mm	AR-9202-34H
IM Reamer, 15 mm	AR-9202-35H
Broach/Trial, 14 mm	AR-9510-14
Broach/Trial, 15 mm	AR-9510-15

Product Description	Item Number
Combination Humeral Trial, 36+3/39	AR-9603-3639-3
Combination Humeral Trial, 36+6/39	AR-9603-3639-6
Combination Humeral Trial, 36+3/39, constrained	AR-9603-3639-3C
Combination Humeral Trial, 36+6/39, constrained	AR-9603-3639-6C
Combination Humeral Trial, 39+3/42	AR-9603-3942-3
Combination Humeral Trial, 39+6/42	AR-9603-3942-6
Combination Humeral Trial, 39+3/42, constrained	AR-9603-3942-3C
Combination Humeral Trial, 39+6/42, constrained	AR-9603-3942-6C
Combination Humeral Trial, 42+3/45	AR-9603-4245-3
Combination Humeral Trial, 42+6/45	AR-9603-4245-6
Combination Humeral Trial, 42+3/45, constrained	AR-9603-4245-3C
Combination Humeral Trial, 42+6/45, constrained	AR-9603-4245-6C
Revision Humeral Instrument Set	AR-9501RHS
IM Reamer, 6 mm, revision	AR-9506-06R
IM Reamer, 9 mm, revision	AR-9506-09R
IM Reamer, 12 mm, revision	AR-9506-12R
Broach/Trial, 6 mm, revision	AR-9510-06R
Broach/Trial, 9 mm, revision	AR-9510-09R
Broach/Trial, 12 mm, revision	AR-9510-12R

## Univers Revers™ Modular Glenoid System



### Baseplates

- 24 mm and 28 mm diameters
- 0 mm, +2 mm, +4 mm lateral augmentation options
- BioSync® matrix with interconnected porosity for ingrowth<sup>3</sup>
- 4 peripheral screw holes accommodate 5.5 mm locking or 4.5 mm nonlocking screws



## Univers Revers™ Modular Glenoid System (Cont.)

### Central Fixation

- Hybrid central screw for compression and ingrowth
- Central post for press-fit and ingrowth
- Numerous lengths to address various glenoid vault depths (15 mm to 35 mm)
- BioSync® matrix with interconnected porosity for ingrowth<sup>3</sup>



### Glenospheres

- 33 mm, 36 mm, 39 mm, 42 mm, and 45 mm diameters
- +0 mm, +4 mm lateralized, and +2.5 mm eccentric offset options
- Titanium options available for patients with cobalt alloy intolerance





## Univers Revers™ Modular Glenoid System (Cont.)

### Implants

Product Description	Item Number
<b>Glenoid Baseplates</b>	
Baseplate, monoblock screw, 24 mm	AR-9560-24S
Baseplate, monoblock post, 24 mm	AR-9560-24P
Baseplate, modular, 24 mm	AR-9560-24
Lateralized baseplate, modular, 24 mm+2	AR-9560-24-2
Lateralized baseplate, modular, 24 mm+4	AR-9560-24-4
Baseplate, modular, 28 mm	AR-9560-28
Lateralized baseplate, modular, 28 mm+2	AR-9560-28-2
Lateralized baseplate, modular, 28 mm+4	AR-9560-28-4
<b>Modular Central Fixation</b>	
Modular Central Screw, 20 mm	AR-9561-20S
Modular Central Screw, 25 mm	AR-9561-25S
Modular Central Screw, 30 mm	AR-9561-30S
Modular Central Screw, 35 mm	AR-9561-35S
Modular Central Post, 20 mm	AR-9561-20P
Modular Central Post, 25 mm	AR-9561-25P
Modular Central Post, 30 mm	AR-9561-30P
Modular Central Post, 35 mm	AR-9561-35P
<b>4.5 mm Nonlocking Peripheral Bone Screws</b>	
Nonlocking Screws, 4.5 mm × 16 mm-48, 16 mm	AR-9562-16NL
Nonlocking Screws, 4.5 mm × 16 mm-48, 20 mm	AR-9562-20NL
Nonlocking Screws, 4.5 mm × 16 mm-48, 24 mm	AR-9562-24NL
Nonlocking Screws, 4.5 mm × 16 mm-48, 28 mm	AR-9562-28NL
Nonlocking Screws, 4.5 mm × 16 mm-48, 32 mm	AR-9562-32NL
Nonlocking Screws, 4.5 mm × 16 mm-48, 36 mm	AR-9562-36NL
Nonlocking Screws, 4.5 mm × 16 mm-48, 40 mm	AR-9562-40NL
Nonlocking Screws, 4.5 mm × 16 mm-48, 44 mm	AR-9562-44NL
Nonlocking Screws, 4.5 mm × 16 mm-48, 48 mm	AR-9562-48NL
<b>5.5 mm Locking Peripheral Bone Screws</b>	
Locking Screws, 5.5 mm × 16 mm-48 mm, 16 mm	AR-9563-16
Locking Screws, 5.5 mm × 16 mm-48 mm, 20 mm	AR-9563-20
Locking Screws, 5.5 mm × 16 mm-48 mm, 24 mm	AR-9563-24
Locking Screws, 5.5 mm × 16 mm-48 mm, 28 mm	AR-9563-28
Locking Screws, 5.5 mm × 16 mm-48 mm, 32 mm	AR-9563-32
Locking Screws, 5.5 mm × 16 mm-48 mm, 36 mm	AR-9563-36
Locking Screws, 5.5 mm × 16 mm-48 mm, 40 mm	AR-9563-40
Locking Screws, 5.5 mm × 16 mm-48 mm, 44 mm	AR-9563-44
Locking Screws, 5.5 mm × 16 mm-48 mm, 48 mm	AR-9563-48
<b>CoCr Glenospheres</b>	
Glenosphere, 33/24	AR-9564-2433
Glenosphere, 33+4 LAT/24	AR-9564-2433-LAT
Glenosphere, 36/24	AR-9564-2436
Glenosphere, 36+4 LAT/24	AR-9564-2436-LAT
Glenosphere, 36+2.5 INF/24	AR-9564-2436-INF
Glenosphere, 39/24	AR-9564-2439
Glenosphere, 39+4 LAT/24	AR-9564-2439-LAT
Glenosphere, 39+2.5 INF/24	AR-9564-2439-INF

Product Description	Item Number
<b>CoCr Glenospheres</b>	
Glenosphere, 42/24	AR-9564-2442
Glenosphere, 42+4 LAT/24	AR-9564-2442-LAT
Glenosphere, 42+2.5 INF/2	AR-9564-2442-INF
Glenosphere, 45/24	AR-9564-2445
Glenosphere, 45+2.5 INF/24	AR-9564-2445-INF
Glenosphere, 45+4 LAT/24	AR-9564-2445-LAT
Glenosphere, 36/28	AR-9564-2836
Glenosphere, 36+4, LAT/28	AR-9564-2836-LAT
Glenosphere, 39/28	AR-9564-2839
Glenosphere, 39+4 LAT/28	AR-9564-2839-LAT
Glenosphere, 39+2.5 INF/28	AR-9564-2839-INF
Glenosphere, 42/28	AR-9564-2842
Glenosphere, 42 LAT/28	AR-9564-2842-LAT
Glenosphere, 42+2.5 INF/28	AR-9564-2842-INF
Glenosphere, 45/28	AR-9564-2845
Glenosphere, 45+2.5 INF/28	AR-9564-2845-INF
Glenosphere, 45+4 LAT/28	AR-9564-2845-LAT
<b>Titanium Glenospheres</b>	
33/24 Ti Glenosphere	AR-9564-T2433
33+4 LAT/24 Ti Glenosphere	AR-9564-T2433-LAT
36/24 Ti Glenosphere	AR-9564-T2436
36+4 LAT/24 Ti Glenosphere	AR-9564-T2436-LAT
36+2.5 INF/24 Ti Glenosphere	AR-9564-T2436-INF
39/24 Ti Glenosphere	AR-9564-T2439
39+4 LAT/24 Ti Glenosphere	AR-9564-T2439-LAT
39+2.5 INF/24 Ti Glenosphere	AR-9564-T2439-INF
42/24 Ti Glenosphere	AR-9564-T2442
42+4 LAT/24 Ti Glenosphere	AR-9564-T2442-LAT
42+2.5 INF/24 Ti Glenosphere	AR-9564-T2442-INF

### Disposables

Product Description	Item Number
Glenosphere Screw, extra	AR-9565
MGS Sterile Pin Kit	AR-9607S
3.0 MGS Sterile Drill Bit	AR-9628S

## Modular Glenoid System, Instrument Set 1

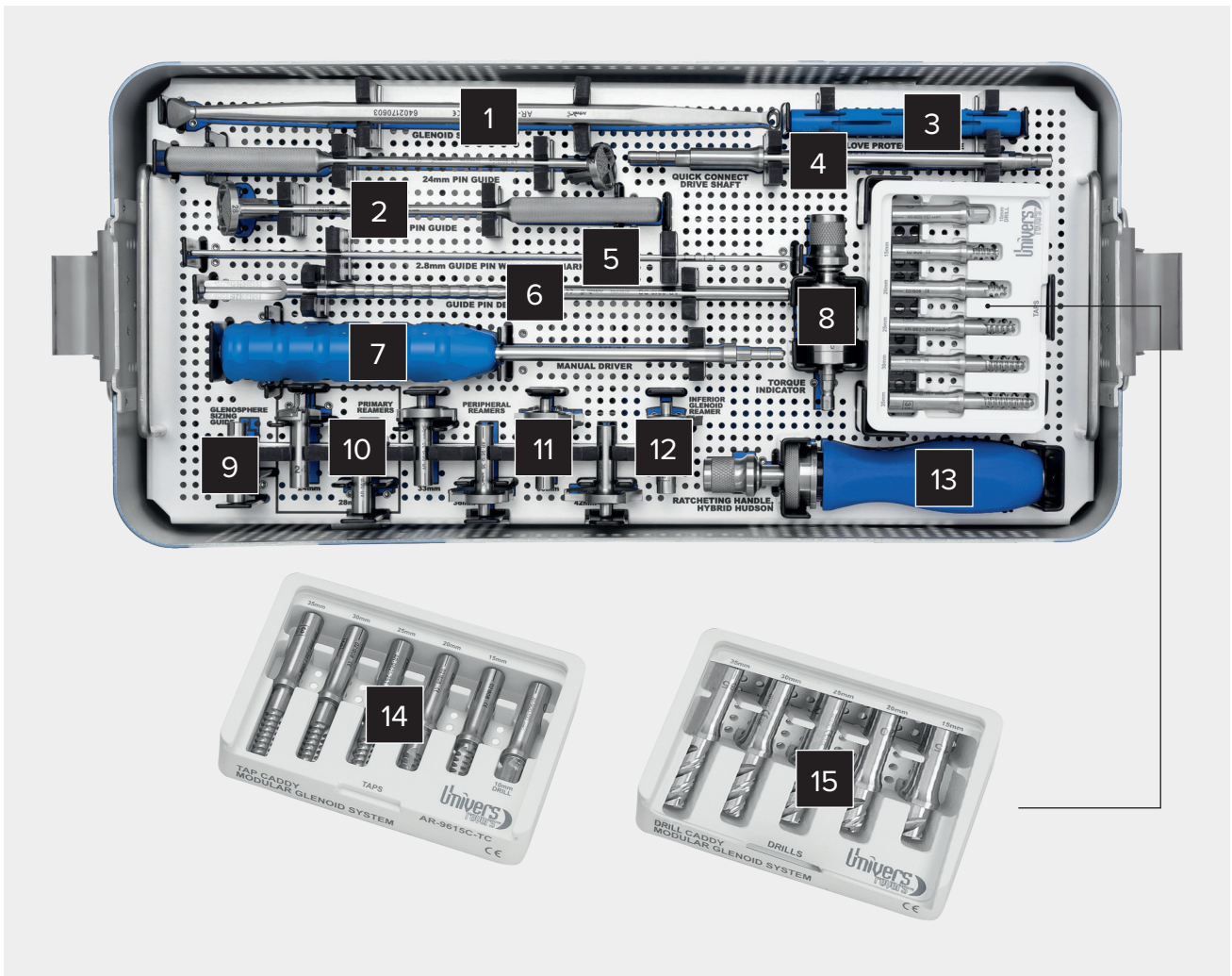

### Modular Glenoid System, Instrument Set 1 - Top Tray (AR-9615C-1)

Label	Product Description	Item Number
1	Glenoid Scrapette	AR-9601
2	Pin Guide, 24 mm Pin Guide, 28 mm	AR-9616-24 AR-9616-28
3	Glove Protector Sleeve, qty. 2	AR-9216-4
4	Modular Reamer Shaft, qty. 2	AR-9617
5	Guide Pin, 2.8 mm, qty. 2	AR-9616
6	Guide Pin Depth Gauge	AR-9616-DG
7	Manual Driver Shaft	AR-9631
8	Torque-Indicating Adapter	AR-9545-T15H
9	Glenosphere Sizing Guide	AR-9664-SG
10	Primary Glenoid Reamer, 24 mm Primary Glenoid Reamer, 28 mm	AR-9618-24 AR-9618-28
11	Peripheral Reamer, 33 mm Peripheral Reamer, 36 mm Peripheral Reamer, 39 mm Peripheral Reamer, 42 mm	AR-9619-33 AR-9619-36 AR-9619-39 AR-9619-42

Label	Product Description	Item Number
12	Inferior Glenoid Reamer	AR-9632-INF
13	Ratcheting Handle, hybrid Hudson	AR-1999HH
14	Tap Caddy Drill, 10 mm Tap, 15 mm Tap, 20 mm Tap, 25 mm Tap, 30 mm Tap, 35 mm	AR-9615C-TC AR-9620-10D AR-9621-15T AR-9621-20T AR-9621-25T AR-9621-30T AR-9621-35T
15	Drill Caddy Drill, 15 mm Drill, 20 mm Drill, 25 mm Drill, 30 mm Drill, 35 mm	AR-9615C-DC AR-9620-15D AR-9620-20D AR-9620-25D AR-9620-30D AR-9620-35D

## Modular Glenoid System, Instrument Set 1 (Cont.)

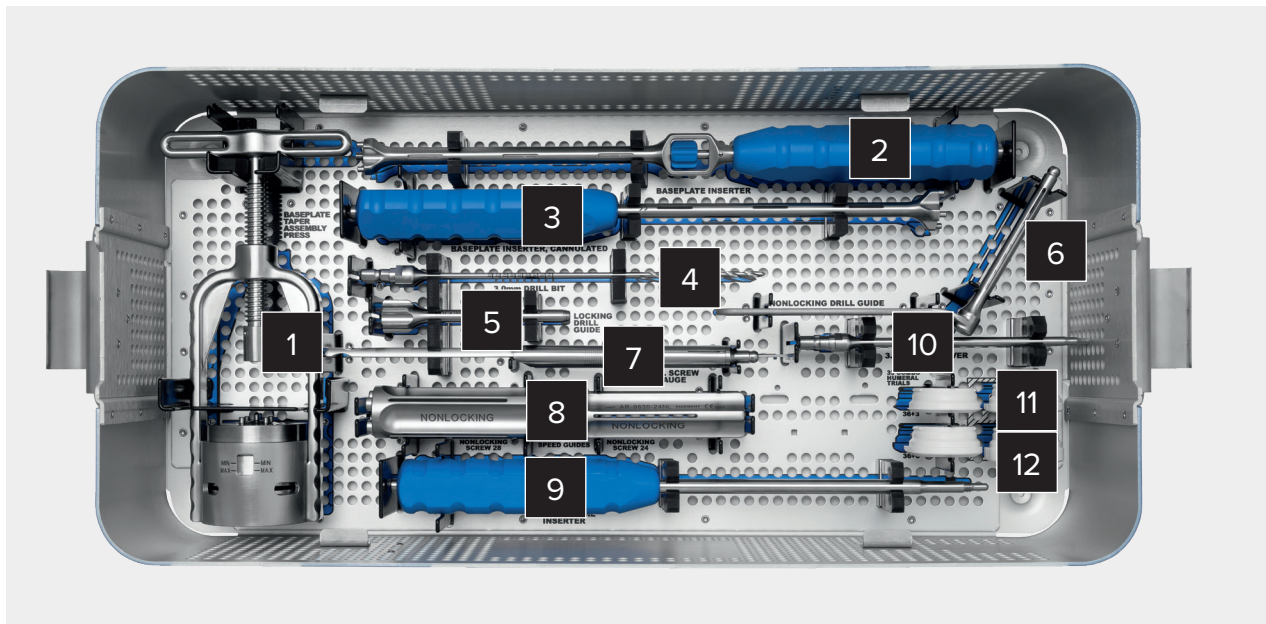

### Modular Glenoid System, Instrument Set 1 - Bottom Tray (AR-9615C-1)

Label	Product Description	Item Number
1	Taper Assembly Press	AR-9622
2	Baseplate Inserter, threaded	AR-9623
3	Baseplate Inserter, cannulated	AR-9623-C
4	Drill, 3 mm, qty. 2	AR-9628
5	Drill Guide, locking screw	AR-9626
6	Drill Guide, nonlocking screw	AR-9627
7	Peripheral Screw Depth Gauge	AR-9629
8	Speed Guide for 24 mm Baseplate Speed Guide for 28 mm Baseplate	AR-9630-24NL AR-9630-28NL
9	Glenosphere Inserter	AR-9624
10	Driver, Hex, 3 mm, qty. 2	AR-9625
11	Combination Humeral Trial, 36+3/33 Combination Humeral Trial, 36+6/33	AR-9603-3633-3 AR-9603-3633-6
12	Constrained Combination Humeral Trial, 36+3/33 Constrained Combination Humeral Trial, 36+6/33	AR-9603-3633-3C AR-9603-3633-6C

## Modular Glenoid System, Instrument Set 2

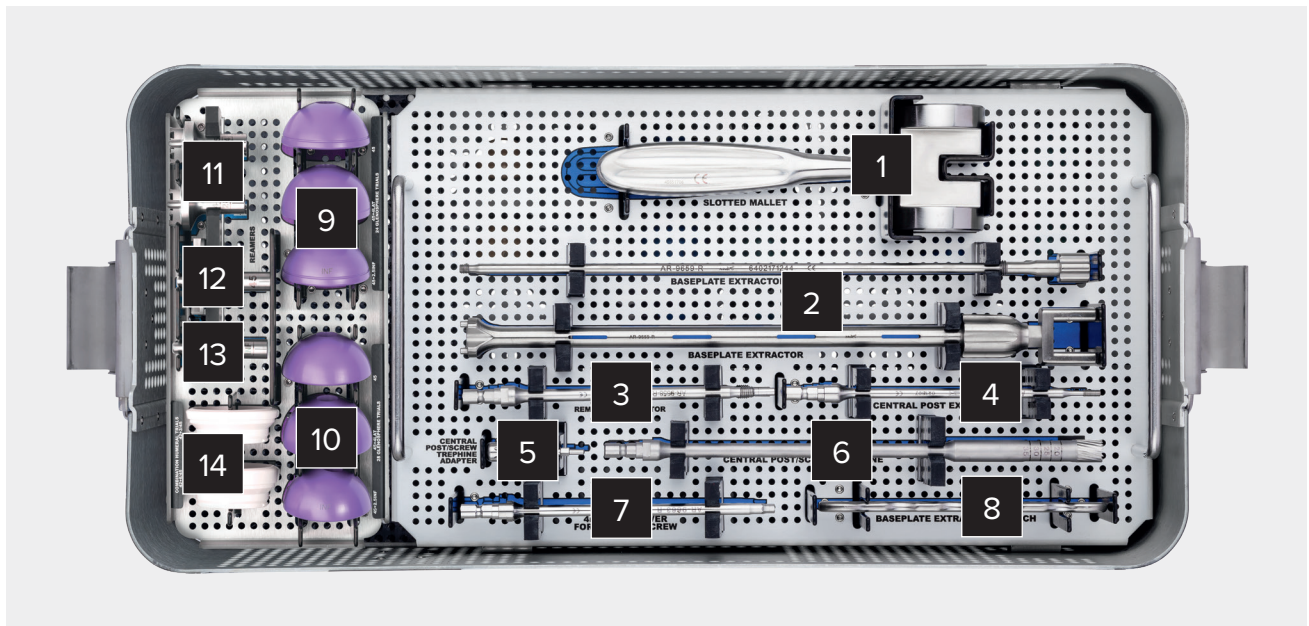

### Modular Glenoid System, Instrument Set 2 - Top Tray (AR-9615C-2)

Label	Product Description	Item Number
1	Mallet, slotted	AR-9231-21
2	Baseplate Extractor and Extractor Shaft	AR-9659-R
3	Glenosphere Distractor	AR-9658-R
4	Central Post Extractor	AR-9660-R
5	Central Post/Screw Trephine Adapter	AR-9661-R
6	Central Post/Screw Trephine	AR-9662-R
7	Driver for Central Screw, 4 mm	AR-9663-R
8	Baseplate Extractor Wrench	AR-9659-RW

### Optional: MGS Size 45 Instrument Set (AR-9615-45S)

Label	Product Description	Item Number
9	Trial Glenosphere, 45/24 Trial Glenosphere, 45+2.5 INF/24 Trial Glenosphere, 45+4 LAT/24	AR-9664-2445 AR-9664-2445-INF AR-9664-2445-LAT
10	Trial Glenosphere, 45/28 Trial Glenosphere, 45+2.5 INF/28 Trial Glenosphere, 45+4 LAT/28	AR-9664-2845 AR-9664-2845-INF AR-9664-2845-LAT
11	Over Baseplate Reamer, 45/24 Over Baseplate Reamer, 45/28	AR-9632-2445 AR-9632-2845
12	45 mm Peripheral Reamer	AR-9619-45
13	Inferior Glenoid Reamer, 45	AR-9632-45INF
14	Combination Humeral Trial, 42+3/45 Combination Humeral Trial, 42+6/45	AR-9603-4245-3 AR-9603-4245-6

## Modular Glenoid System, Instrument Set 2 (Cont.)



### Modular Glenoid System, Instrument Set 2 - Bottom Tray (AR-9615C-2)

Label	Product Description	Item Number
1	Trial Glenosphere, 33/24 Trial Glenosphere, 33+4 LAT/24	AR-9664-2433 AR-9664-2433-LAT
2	Trial Glenosphere, 36/24 Trial Glenosphere, 36+2.5 INF/24 Trial Glenosphere, 36+4 LAT/24	AR-9664-2436 AR-9664-2436-INF AR-9664-2436-LAT
3	Trial Glenosphere, 39/24 Trial Glenosphere 39+2.5 INF/24 Trial Glenosphere, 39+4 LAT/24	AR-9664-2439 AR-9664-2439-INF AR-9664-2439-LAT
4	Trial Glenosphere, 42/24 Trial Glenosphere, 42+2.5 INF/24 Trial Glenosphere, 42+4 LAT/24	AR-9664-2442 AR-9664-2442-INF AR-9664-2442-LAT
5	Trial Glenosphere, 36/28 Trial Glenosphere, 36+4 LAT/28	AR-9664-2836 AR-9664-2836-LAT
6	Trial Glenosphere, 39/28 Trial Glenosphere, 39+2.5 INF/28 Trial Glenosphere, 39+4 LAT/28	AR-9664-2839 AR-9664-2839-INF AR-9664-2839-LAT
7	Trial Glenosphere, 42/28 Trial Glenosphere, 42+2.5 INF/28 Trial Glenosphere, 42+4 LAT/28	AR-9664-2842 AR-9664-2842-INF AR-9664-2842-LAT
8	Over Baseplate Reamer, 36/24 Over Baseplate Reamer, 39/24 Over Baseplate Reamer, 42/24 Over Baseplate Reamer, 36/28 Over Baseplate Reamer, 39/28 Over Baseplate Reamer, 42/28	AR-9632-2436 AR-9632-2439 AR-9632-2442 AR-9632-2836 AR-9632-2839 AR-9632-2842

## Bone Graft Preparation for the Univers Revers™ Modular Glenoid System (AR-9665S)



### Technique Precision in Harvesting, Shaping, and Preparing Bony Augments

- Humeral sizing instruments available in both 135° and 155°
- Glenoid defect gauge to determine the angle/thickness of the graft required
- Adjustable variable drill for precision in central vault drilling length

### Disposables

Product Description	Item Number
Angled Reamer, small	AR-9675-S
Angled Reamer, medium	AR-9675-M
Angled Reamer, large	AR-9675-L
Angled Reamer, extra large	AR-9675-XL

## Bone Graft Instrument Set

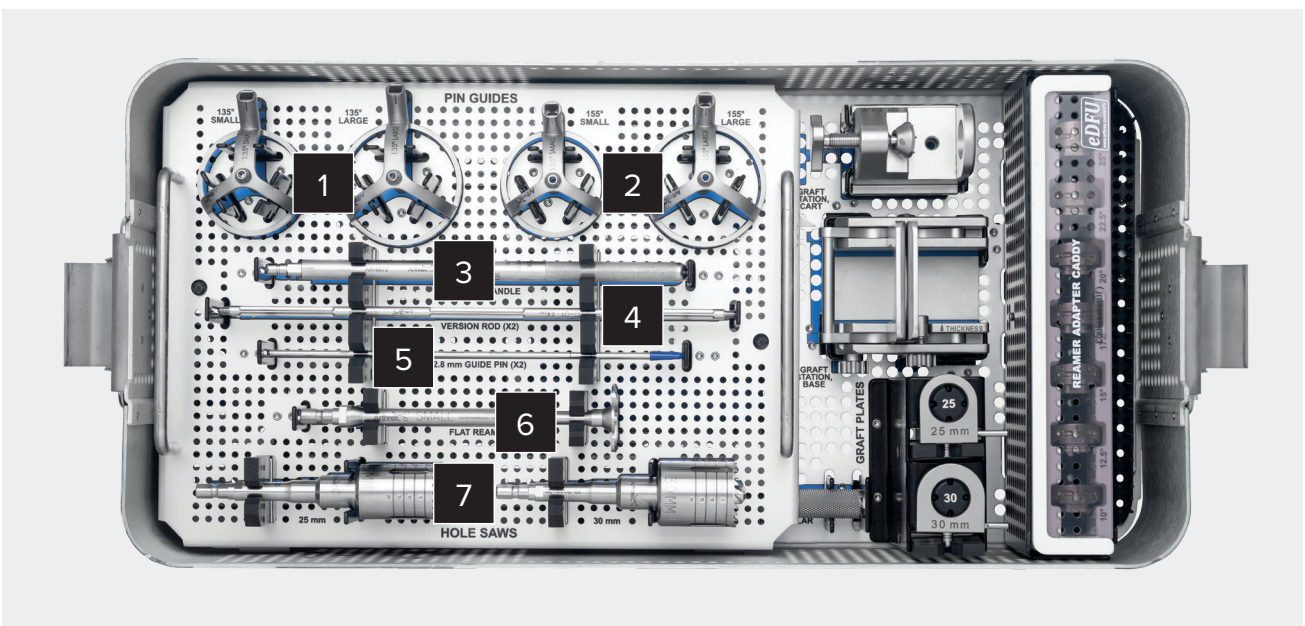

### Bone Graft Instrument Set - Top Tray (AR-9665S)

Label	Product Description	Item Number
1	Pin Guide, 135°, 2.8 mm, small Pin Guide, 135°, 2.8 mm, large	AR-9672-135S AR-9672-135L
2	Pin Guide, 155°, 2.8 mm, small Pin Guide, 155°, 2.8 mm, large	AR-9672-155S AR-9672-155L
3	Pin Guide, handle, 2.8 mm	AR-9672
4	Univers Revers Version Rod	AR-9510-01
5	Guide Pin, 2.8 mm	AR-9165K
6	Univers Revers Flat Reamer, cannulated, 33 mm diameter, small	AR-9128RF-01
7	Hole Saw, cannulated, Ø25 mm, w/ Ø9.5 mm, central bit Hole Saw, cannulated, Ø30 mm, w/ Ø9.5 mm, central bit	AR-9669-25 AR-9669-30

## Bone Graft Instrument Set (Cont.)

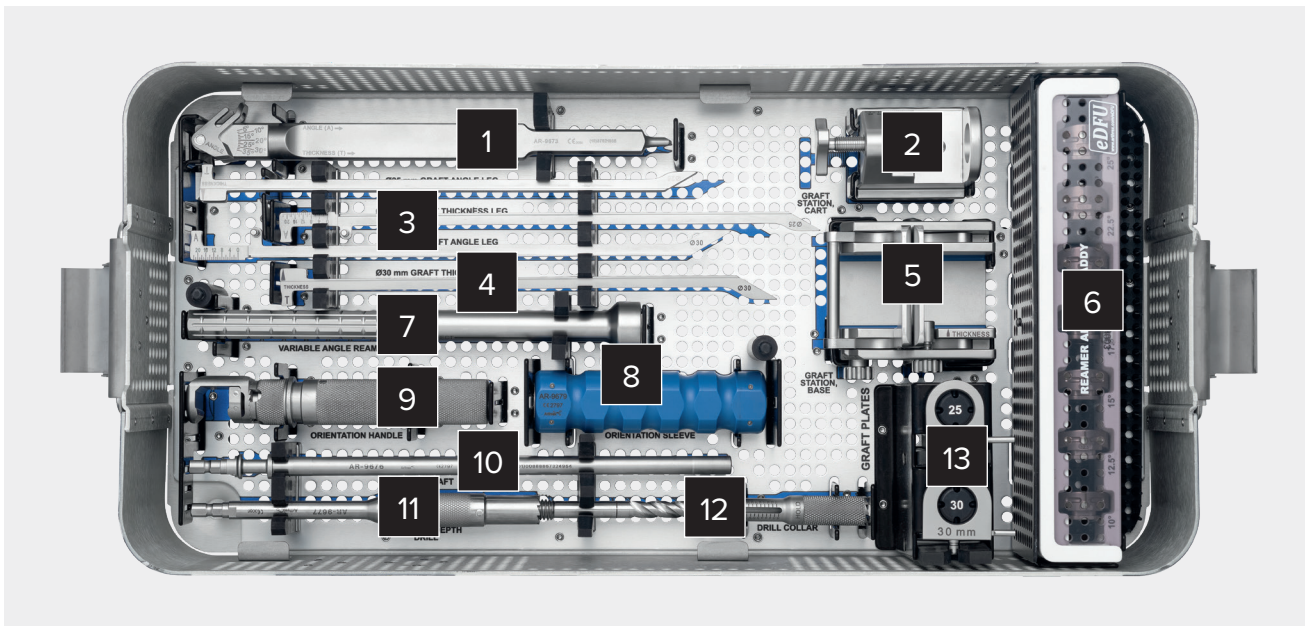

### Bone Graft Instrument Set - Bottom Tray (AR-9665S)

Label	Product Description	Item Number
1	Glenoid Defect Gauge, housing	AR-9673
2	Graft Preparation Station, cart	AR-9670-2
3	Glenoid Defect Gauge, $\varnothing 25$ mm graft angle leg Glenoid Defect Gauge, $\varnothing 25$ mm graft thickness leg	AR-9673-25A AR-9673-25T
4	Glenoid Defect Gauge, $\varnothing 30$ mm graft angle leg Glenoid Defect Gauge, $\varnothing 30$ mm graft thickness leg	AR-9673-30A AR-9673-30T
5	Graft Preparation Station, base	AR-9670-1
6	Reamer Adapter, 10° Reamer Adapter, 12.5° Reamer Adapter, 15° Reamer Adapter, 17.5° Reamer Adapter, 20° Reamer Adapter, 22.5° Reamer Adapter, 25°	AR-9674-10 AR-9674-125 AR-9674-15 AR-9674-175 AR-9674-20 AR-9674-225 AR-9674-25
7	Modular Reamer Sleeve	AR-9674
8	Angled Reamer, orientation sleeve	AR-9679
9	Angled Reamer, orientation handle	AR-9678
10	Angled Reamer, drive shaft	AR-9676
11	Variable Depth Central Post Drill, shaft	AR-9677
12	Variable Depth Central Post Drill, adjustment collar	AR-9677-1
13	Graft Preparation Raise Plate, $\varnothing 25$ mm graft Graft Preparation Raise Plate, $\varnothing 30$ mm graft	AR-9670-3 AR-9670-4

## Univers Revers™ Augmented Modular Glenoid System



### Baseplates

- 10° and 20° full-wedge
- 15°, 25°, and 35° half-wedge
- 24 mm and 28 mm diameters
- Available with 2 mm of additional lateral offset
- Standard or oblique augment orientation
- BioSync® matrix with interconnected porosity for ingrowth<sup>3</sup>
- 4 peripheral screw holes accommodate 5.5 mm locking or 4.5 mm nonlocking screws

### Central Fixation

- Central post for press-fit and ingrowth
- Numerous lengths to address various glenoid vault depths (20 mm to 40 mm)
- BioSync matrix with interconnected porosity for ingrowth<sup>3</sup>

### Glenospheres

- Compatible with all MGS glenospheres



## Univers Revers™ Augmented Modular Glenoid System (Cont.)

### Implants

Product Description	Item Number
<b>Full-Wedge</b>	
24 mm Baseplate, 10° full-wedge, oblique	AR-9580-2410
24 mm Baseplate, 20° full-wedge, oblique	AR-9580-2420
24 mm Baseplate, 10° full-wedge, +2 lateralized, oblique	AR-9580-2410-2
24 mm Baseplate, 20° full-wedge, +2 lateralized, oblique	AR-9580-2420-2
24 mm Baseplate, 10° full-wedge	AR-9580-2410S
24 mm Baseplate, 20° full-wedge	AR-9580-2420S
24 mm Baseplate, 10° full-wedge, +2 lateralized	AR-9580-2410-2S
24 mm Baseplate, 20° full-wedge, +2 lateralized	AR-9580-2420-2S
28 mm Baseplate, 10° full-wedge, oblique	AR-9580-2810
28 mm Baseplate, 20° full-wedge, oblique	AR-9580-2820
28 mm Baseplate, 10° full-wedge, +2 lateralized, oblique	AR-9580-2810-2
28 mm Baseplate, 20° full-wedge, +2 lateralized, oblique	AR-9580-2820-2
28 mm Baseplate, 10° full-wedge	AR-9580-2810S
28 mm Baseplate, 20° full-wedge	AR-9580-2820S
28 mm Baseplate, 10° full-wedge, +2 lateralized	AR-9580-2810-2S
28 mm Baseplate, 20° full-wedge, +2 lateralized	AR-9580-2820-2S
<b>Half-Wedge</b>	
24 mm Baseplate, 15° half-wedge, oblique	AR-9581-2415
24 mm Baseplate, 25° half-wedge, oblique	AR-9581-2425
24 mm Baseplate, 35° half-wedge, oblique	AR-9581-2435
24 mm Baseplate, 15° half-wedge, +2 lateralized, oblique	AR-9581-2415-2
24 mm Baseplate, 25° half-wedge, +2 lateralized, oblique	AR-9581-2425-2
24 mm Baseplate, 35° half-wedge, +2 lateralized, oblique	AR-9581-2435-2
24 mm Baseplate, 15° half-wedge	AR-9581-2415S
24 mm Baseplate, 25° half-wedge	AR-9581-2425S
24 mm Baseplate, 35° half-wedge	AR-9581-2435S
24 mm Baseplate, 15° half-wedge, +2 lateralized	AR-9581-2415-2S
24 mm Baseplate, 25° half-wedge, +2 lateralized	AR-9581-2425-2S
24 mm Baseplate, 35° half-wedge, +2 lateralized	AR-9581-2435-2S
28 mm Baseplate, 15° half-wedge, oblique	AR-9581-2815
28 mm Baseplate, 25° half-wedge, oblique	AR-9581-2825
28 mm Baseplate, 35° half-wedge, oblique	AR-9581-2835
28 mm Baseplate, 15° half-wedge, +2 lateralized, oblique	AR-9581-2815-2
28 mm Baseplate, 25° half-wedge, +2 lateralized, oblique	AR-9581-2825-2
28 mm Baseplate, 35° half-wedge, +2 lateralized, oblique	AR-9581-2835-2
28 mm Baseplate, 15° half-wedge	AR-9581-2815S
28 mm Baseplate, 25° half-wedge	AR-9581-2825S
28 mm Baseplate, 35° half-wedge	AR-9581-2835S
28 mm Baseplate, 15° half-wedge, +2 lateralized	AR-9581-2815-2S
28 mm Baseplate, 25° half-wedge, +2 lateralized	AR-9581-2825-2S
28 mm Baseplate, 35° half-wedge, +2 lateralized	AR-9581-2835-2S

Product Description	Item Number
<b>Central Posts</b>	
Modular Post, 20 mm	AR-9582-20
Modular Post, 25 mm	AR-9582-25
Modular Post, 30 mm	AR-9582-30
Modular Post, 35 mm	AR-9582-35
Modular Post, 40 mm	AR-9582-40

### Disposables

Product Description	Item Number
Angled Reamer, small	AR-9675-S
Angled Reamer, medium	AR-9675-M
Angled Reamer, large	AR-9675-L
Angled Reamer, extra large	AR-9675-XL
3.0 mm Drill	AR-9628S

## Augmented Modular Glenoid System Instrument Set

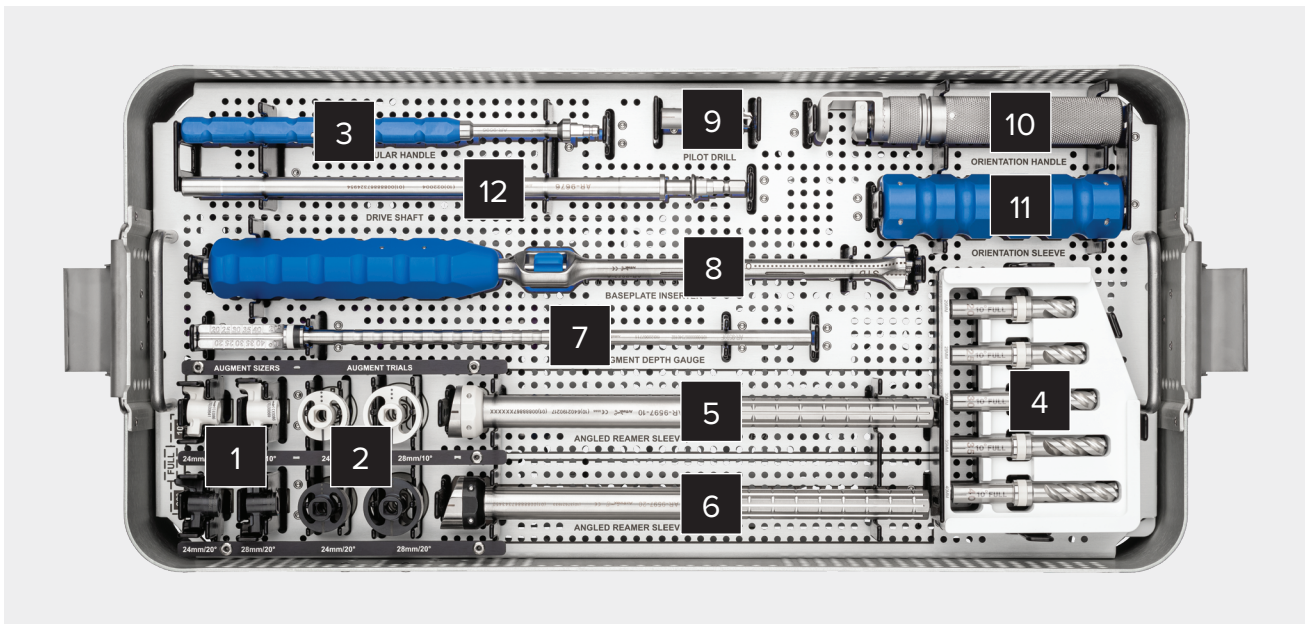

### Augmented Modular Glenoid System Instrument Set - Top Tray (AR-9579S)

Label	Product Description	Item Number
1	24 mm Baseplate, 10° full-wedge augment sizer	AR-9592-2410
	24 mm Baseplate, 20° full-wedge augment sizer	AR-9592-2420
	28 mm Baseplate, 10° full-wedge augment sizer	AR-9592-2810
	28 mm Baseplate, 20° full-wedge augment sizer	AR-9592-2820
2	24 mm Baseplate, 10° full-wedge augment trial	AR-9594-2410
	24 mm Baseplate, 20° full-wedge augment trial	AR-9594-2420
	28 mm Baseplate, 10° full-wedge augment trial	AR-9594-2810
	28 mm Baseplate, 20° full-wedge augment trial	AR-9594-2820
3	Modular Handle	AR-9595
4	Modular Drills, 10° full, 20 mm	AR-9596-1020F
	Modular Drills, 10° full, 25 mm	AR-9596-1025F
	Modular Drills, 10° full, 30 mm	AR-9596-1030F
	Modular Drills, 10° full, 35 mm	AR-9596-1035F
	Modular Drills, 10° full, 40 mm	AR-9596-1040F
	Modular Drills, 20° full, 20 mm	AR-9596-2020F
	Modular Drills, 20° full, 25 mm	AR-9596-2025F
	Modular Drills, 20° full, 30 mm	AR-9596-2030F
	Modular Drills, 20° full, 35 mm	AR-9596-2035F
	Modular Drills, 20° full, 40 mm	AR-9596-2040F
5	Angled Reamer Sleeve, 10°	AR-9597-10
6	Angled Reamer Sleeve, 20°	AR-9597-20
7	Full-Wedge Augment Depth Gauge	AR-9599F
8	Baseplate Inserter	AR-9623-A
9	Pilot Drill	AR-9596-P
10	Angled Reamer, orientation handle	AR-9678
11	Angled Reamer, orientation sleeve	AR-9679
12	Angled Reamer, drive shaft	AR-9676

## Augmented Modular Glenoid System Instrument Set (Cont.)

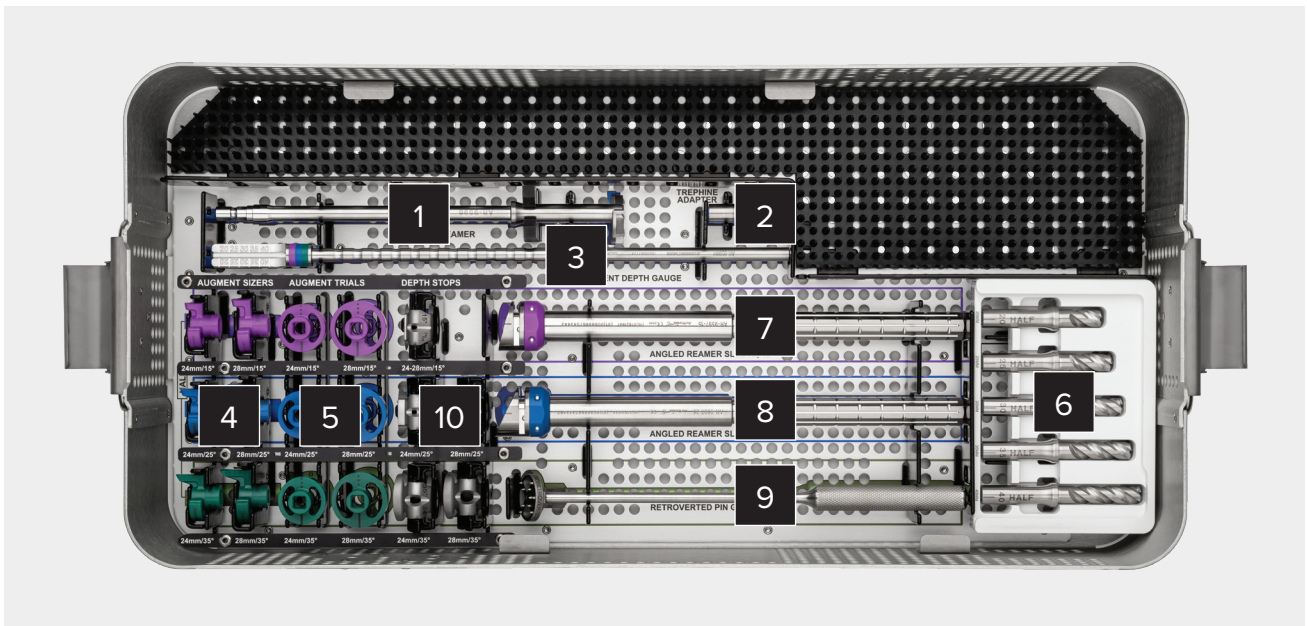

### Augmented Modular Glenoid System Instrument Set - Bottom Tray (AR-9579S)

Label	Product Description	Item Number
1	Paleo Reamer	AR-9596
2	Trephine Adapter	AR-9661-A
3	Half-Wedge Depth Gauge	AR-9599H
4	24 mm Baseplate, 15° half-wedge augment sizer 24 mm Baseplate, 25° half-wedge augment sizer 24 mm Baseplate, 35° half-wedge augment sizer 28 mm Baseplate, 15° half-wedge augment sizer 28 mm Baseplate, 25° half-wedge augment sizer 28 mm Baseplate, 35° half-wedge augment sizer	AR-9591-2415 AR-9591-2425 AR-9591-2435 AR-9591-2815 AR-9591-2825 AR-9591-2835
5	24 mm Baseplate, 15° half-wedge augment trial 24 mm Baseplate, 25° half-wedge augment trial 24 mm Baseplate, 35° half-wedge augment trial 28 mm Baseplate, 15° half-wedge augment trial 28 mm Baseplate, 25° half-wedge augment trial 28 mm Baseplate, 35° half-wedge augment trial	AR-9593-2415 AR-9593-2425 AR-9593-2435 AR-9593-2815 AR-9593-2825 AR-9593-2835
6	20 mm Modular Drill, half 25 mm Modular Drill, half 30 mm Modular Drill, half 35 mm Modular Drill, half 40 mm Modular Drill, half	AR-9596-20H AR-9596-25H AR-9596-30H AR-9596-35H AR-9596-40H
7	Angled Reamer Sleeve, 15°	AR-9597-15
8	Angled Reamer Sleeve, 25°	AR-9597-25
9	Retroverted Pin Guide	AR-9680
10	24/28 mm Depth Stop, 15° 24 mm Depth Stop, 25° 28 mm Depth Stop, 25° 24 mm Depth Stop, 35° 28 mm Depth Stop, 35°	AR-9598-15 AR-9598-2425 AR-9598-2825 AR-9598-2435 AR-9598-2835

## Univers Revers™ Fracture Adapter



- Compatible with all sizes of Univers Revers humeral stems
- Suture holes for tuberosity fixation
- Machine-textured, grit-blasted, and hydroxyapatite (HA)-coated for bony ongrowth
- Narrow and wide sizes available:
  - Size 5: +11 mm
  - Sizes 6-9: +9.5 mm
  - Sizes 10-15: +7.5 mm
- Heights available as standard and +5 mm

## Univers Revers™ Fracture Adapter (Cont.)

### Implants

Product Description	Item Number
Fracture Adapter, sizes 6-9	AR-9501-FX6N
Fracture Adapter, sizes 6-9, wide	AR-9501-FX6W
Fracture Adapter, sizes 6-9, tall	AR-9501-FX6NT
Fracture Adapter, sizes 6-9, wide, tall	AR-9501-FX6WT
Fracture Adapter, sizes 10-15	AR-9501-FX10N
Fracture Adapter, sizes 10-15, wide	AR-9501-FX10W
Fracture Adapter, sizes 10-15, tall	AR-9501-FX10NT
Fracture Adapter, sizes 10-15, wide, tall	AR-9501-FX10WT
Fracture Adapter, size 5	AR-9501-FX5N
Fracture Adapter, size 5, wide	AR-9501-FX5W
Fracture Adapter Trunnion	AR-9501FTK

### Disposables

Product Description	Item Number
FiberWire® Suture Kit	AR-7219
#2 FiberWire Suture (blue), 97 cm, w/ tapered needle, 26.5 mm, ½ circle, qty. 12	AR-7200
#2 FiberWire Suture, 97 cm, w/ reverse cutting needle, 36.6 mm, ½ circle, qty. 12	AR-7202
#5 FiberWire Suture (blue), 97 cm	AR-7210
#5 FiberWire Suture, 97 cm, w/ conventional cutting needle, 48 mm, ½ circle, qty. 12	AR-7211

### Fracture Adapter Case (AR-9510FX)

Product Description	Item Number
Trial Fracture Adapter, size 5, narrow	AR-9510-FX5N
Trial Fracture Adapter, size 5, wide	AR-9510-FX5W
Trial Fracture Adapter, sizes 6- 9, narrow	AR-9510-FX6N
Trial Fracture Adapter, sizes 6- 9, wide	AR-9510-FX6W
Trial Fracture Adapter, sizes 6-9, narrow, tall	AR-9510-FX6NT
Trial Fracture Adapter, sizes 6-9, wide, tall	AR-9510-FX6WT
Trial Fracture Adapter, sizes 10-15, narrow	AR-9510-FX10N
Trial Fracture Adapter, sizes 10-15, wide	AR-9510-FX10W
Trial Fracture Adapter, sizes 10-15, narrow, tall	AR-9510-FX10NT
Trial Fracture Adapter, sizes 10-15, wide, tall	AR-9510-FX10NW
Fracture Adapter Impactor	AR-9510-F1
Fracture Adapter Extractor	AR-9510-F2
Fracture Adapter Extractor Shaft	AR-9510-F3

## FxBridge™ Tuberosity Repair System (AR-9517)

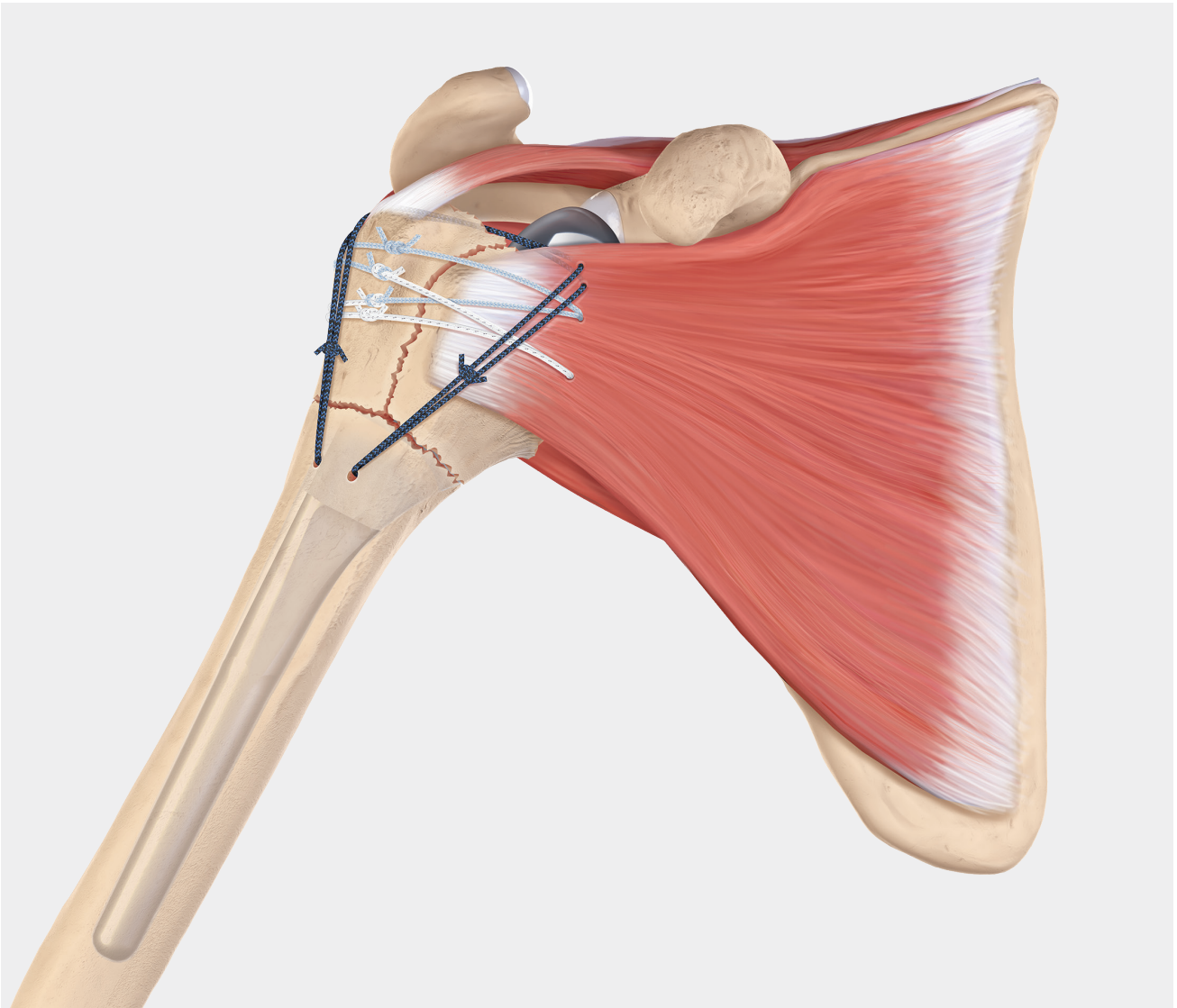

- All-inclusive kit streamlines repairs during a case
- Three distinct suture colors aid in suture management for a simple, reproducible repair
- Provides an environment for tuberosity healing, which improves postoperative range of motion (ROM)<sup>4</sup>
- FiberTape suture is 27% more resistant to tissue pull-through compared to round #2 suture<sup>5</sup>
- 135° humeral inclination increases tuberosity healing rate and stability<sup>6</sup>

## Shoulder Arthroplasty Retractor Set

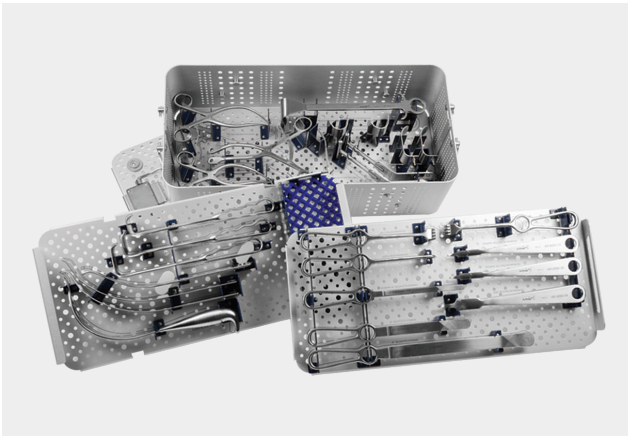

- More than 25 standard and specialty retractors
- Most extensive shoulder arthroplasty-specific retractor grouping on the market

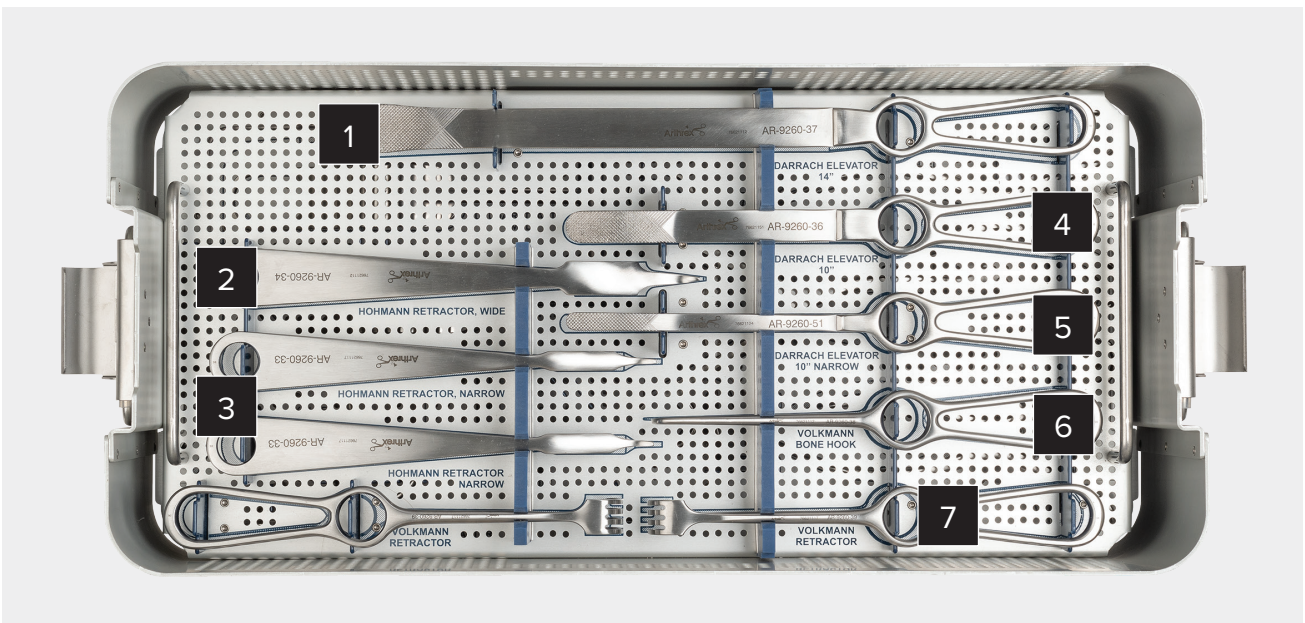

### Shoulder Arthroplasty Retractor Set - Top Tray (AR-9260S-53)

Label	Product Description	Item Number
1	Darrach Elevator, 14 in (L) × 1 in (W)	AR-9260-37
2	Hohmann Retractor, wide	AR-9260-34
3	Hohmann Retractor, narrow	AR-9260-33
4	Darrach Elevator, 10 in (L) × 5/8 in (W)	AR-9260-36
5	Darrach Elevator, 10 in (L) × 3/8 in (W)	AR-9260-51
6	Volkman Bone Hook	AR-9260-38
7	Volkman "Rake" Retractor	AR-9260-39

## Shoulder Arthroplasty Retractor Set (Cont.)

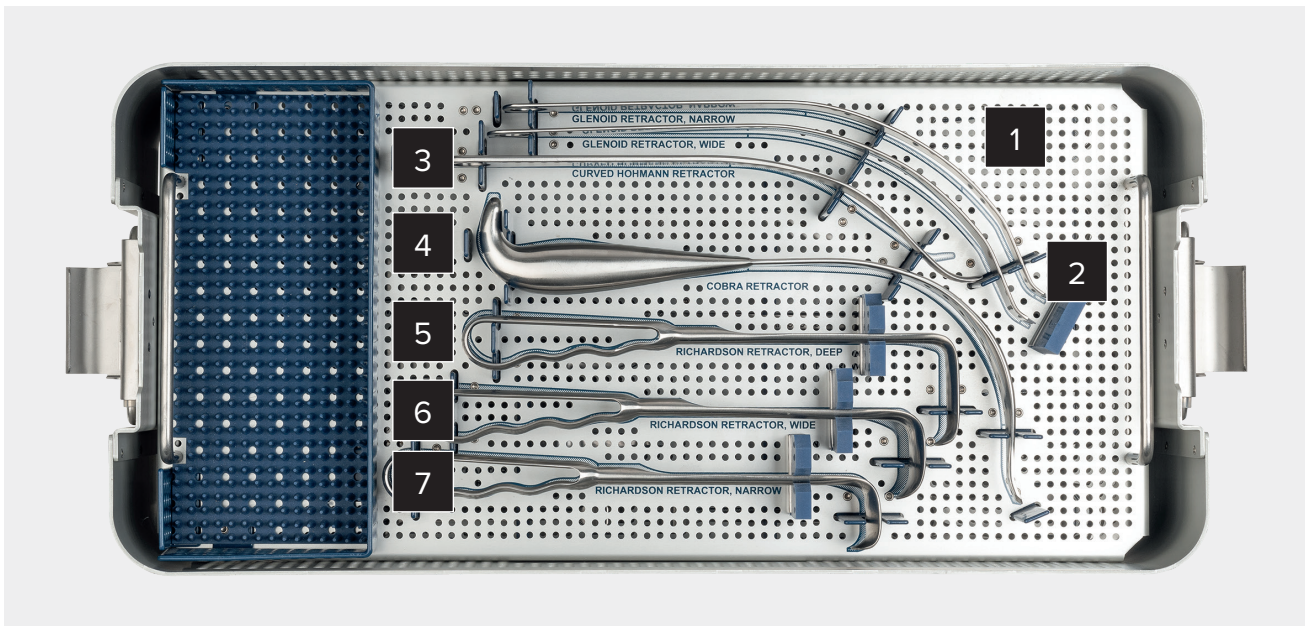

### Shoulder Arthroplasty Retractor Set - Middle Tray (AR-9260S-53)

Label	Product Description	Item Number
1	Thin Glenoid Retractor, narrow tip	AR-9260-30
2	Thin Glenoid Retractor, wide tip	AR-9260-31
3	Hohmann Retractor, curved	AR-9260-35
4	Cobra Retractor	AR-9260-49
5	Richardson Retractor, deep	AR-9260-42
6	Richardson Retractor, wide	AR-9260-41
7	Richardson Retractor, narrow	AR-9260-40



## Shoulder Arthroplasty Retractor Set (Cont.)

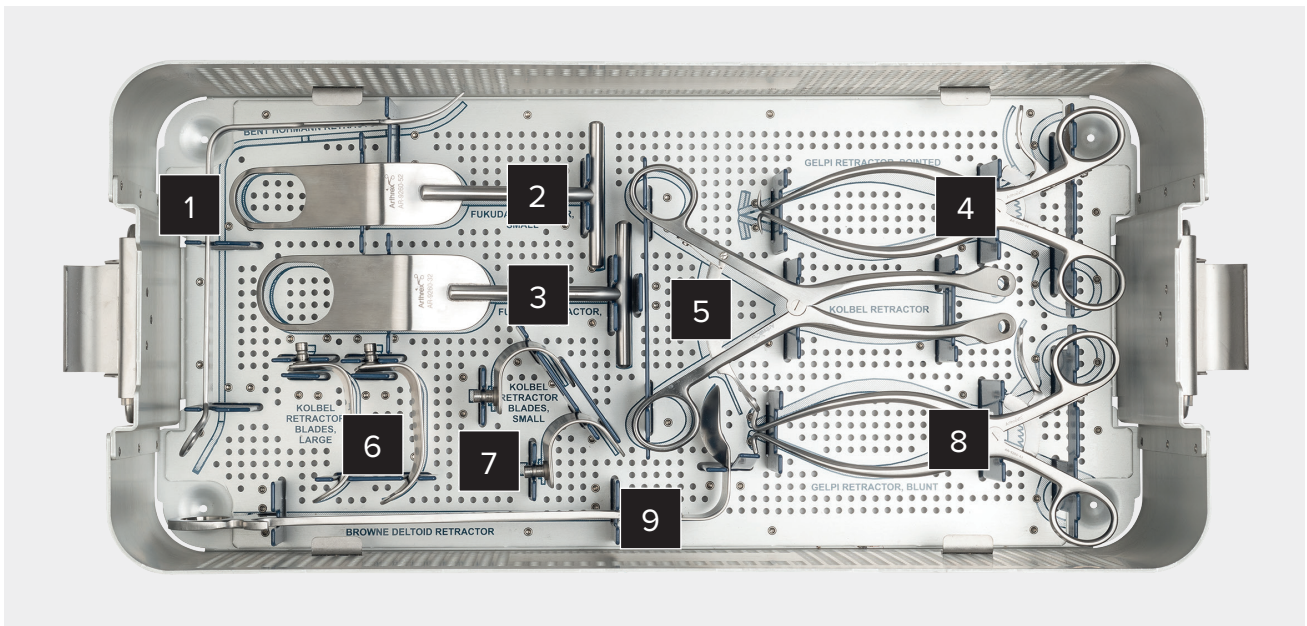

### Shoulder Arthroplasty Retractor Set - Bottom Tray (AR-9260S-53)

Label	Product Description	Item Number
1	Hohmann Retractor, bent	AR-9260-48
2	Fukuda Retractor, small	AR-9260-52
3	Fukuda Retractor, large	AR-9260-32
4	Gelpi Retractor, sharp tip	AR-9260-44
5	Kolbel Retractor, ring handle	AR-9260-45
6	Kolbel Retractor Blades, large	AR-9260-47
7	Kolbel Retractor Blades, small	AR-9260-46
8	Gelpi Retractor, blunt tip	AR-9260-43
9	Browne Deltoid Retractor	AR-9260-50

## Virtual Implant Positioning™ (VIP™) System



### Optimized for Surgeon Control and Capability

- Team of dedicated surgical planners use the patient's uploaded CT data to develop a preoperative plan that is subsequently reviewed and adjusted, as necessary, by the surgeon
- 2-day turnaround once plan is approved
- Plan and easily switch between anatomic and reverse total shoulder arthroplasty cases
- Web-based portal available on desktop, mobile, and iOS tablet devices

### Reusable, Adjustable, Patient-Specific Instrumentation

- Facilitates accurate, intraoperative placement of the glenoid guide pin based on the surgeon-approved preoperative plan
- The glenoid targeter (a) is used intraoperatively to transfer the planned glenoid guide pin position and trajectory from the software to the patient's anatomy
- The VIP glenoid reamer (b) can be used to transfer the desired depth of ream from the VIP plan to the patient's anatomy
- A 3D glenoid model (a) of the patient's anatomy can be ordered

### MyVIP™ Texting Platform

- Delivers timely, automated text messages to guide patients through their presurgical journey
- Educate patients and ease anxiety-ridden waiting time
- Based on patients' MyVIP experience alone<sup>7</sup>:
  - 91% would refer their surgeon to a friend or family member
  - 97% understand why a CT scan was needed
  - 94% were satisfied with communication and information

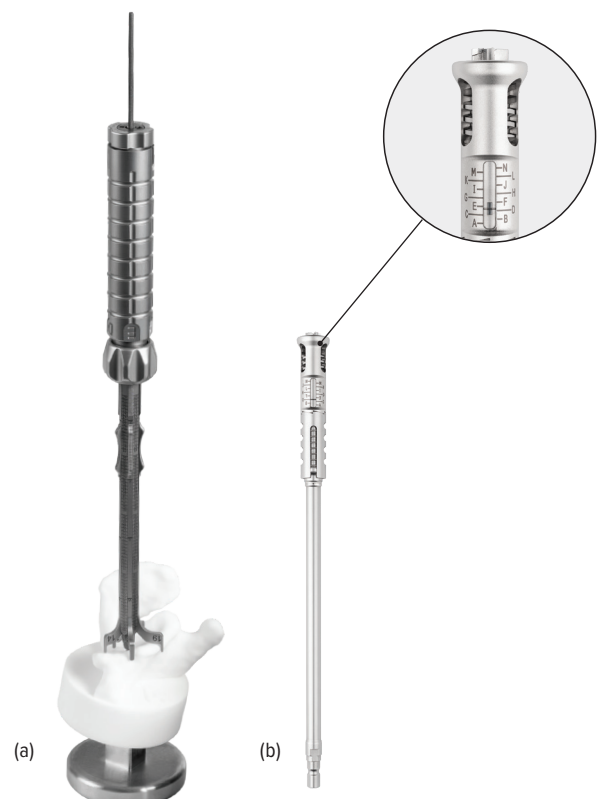

## Glenoid Targeter Instrument Set

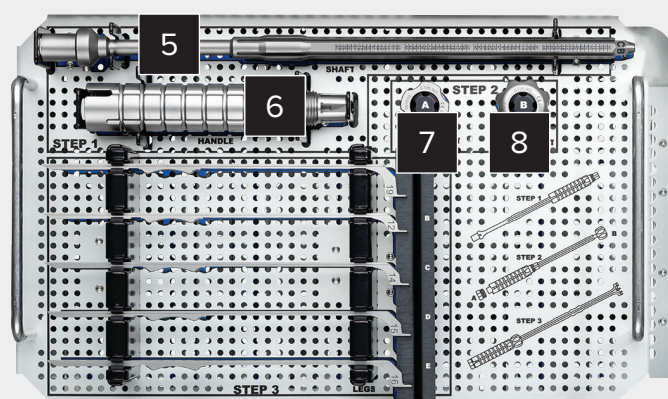
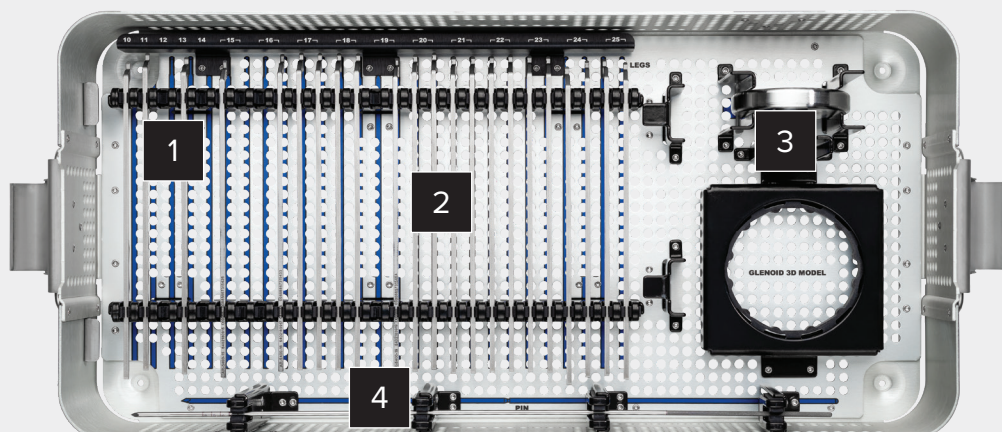

Glenoid Targeter Instrument Set - Case Base  
(DE-VIPTARG2-IN)

Label	Product Description	Item Number
1	Glenoid Targeter Leg, size 10	AR-5400-10
	Glenoid Targeter Leg, size 11	AR-5400-11
	Glenoid Targeter Leg, size 12	AR-5400-12
	Glenoid Targeter Leg, size 13	AR-5400-13
	Glenoid Targeter Leg, size 14	AR-5400-14
2	Glenoid Targeter Leg, size 15	AR-5400-15
	Glenoid Targeter Leg, size 16	AR-5400-16
	Glenoid Targeter Leg, size 17	AR-5400-17
	Glenoid Targeter Leg, size 18	AR-5400-18
	Glenoid Targeter Leg, size 19	AR-5400-19
	Glenoid Targeter Leg, size 20	AR-5400-20
	Glenoid Targeter Leg, size 21	AR-5400-21
	Glenoid Targeter Leg, size 22	AR-5400-22
	Glenoid Targeter Leg, size 23	AR-5400-23
	Glenoid Targeter Leg, size 24	AR-5400-24
	Glenoid Targeter Leg, size 25	AR-5400-25
3	VIP™ Glenoid 3D Model Base	AR-VIPBASE
4	2.8 mm Pin, stainless steel	AR-5400-400

Glenoid Targeter Instrument Set - Case Insert  
(DE-VIPTARG2-IN)

Label	Product Description	Item Number
5	Glenoid Targeter Shaft	AR-5400-01
6	Glenoid Targeter Handle	AR-5400-02
7	Glenoid Targeter Capture Nut	AR-5400-03
8	Glenoid Targeter Locking Nut	AR-5400-04

## VIP™ Glenoid Reaming System Set

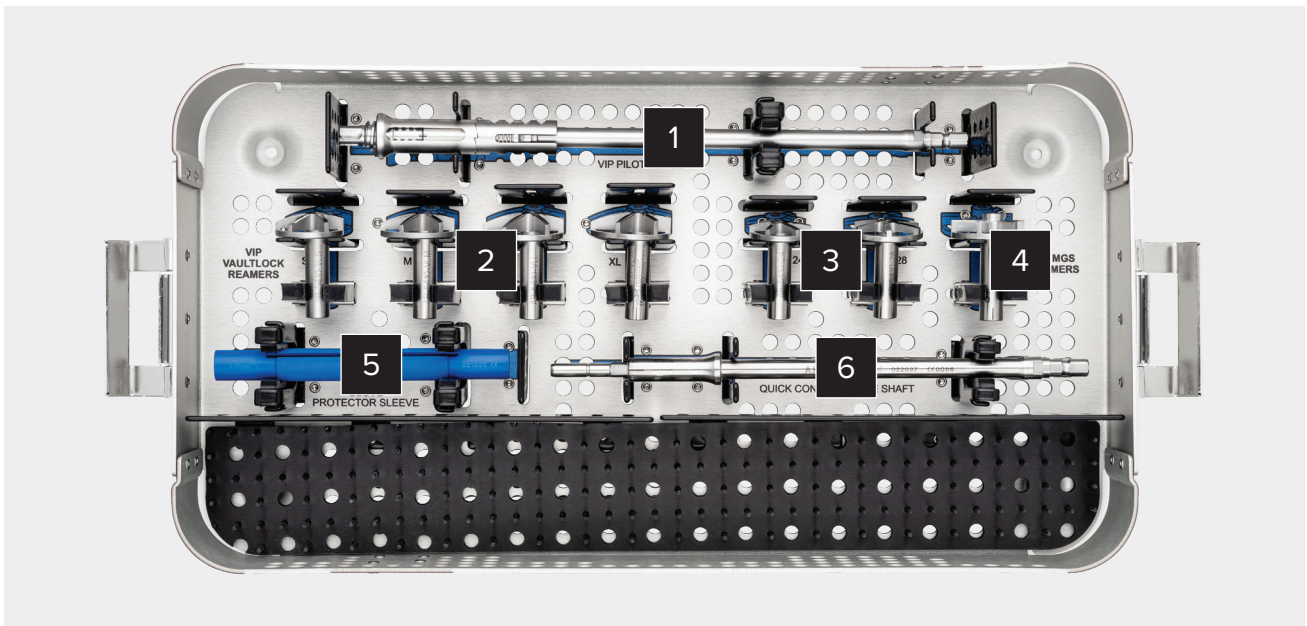

### VIP Glenoid Reaming System Set - Reusable Instruments (AR-5410S)

Label	Product Description	Item Number
1	Virtual Implant Positioning™ Glenoid Reamer, pilot	AR-5410-01
2	VIP Glenoid Reamer, Univers VaultLock® glenoid, small VIP Glenoid Reamer, Univers VaultLock glenoid, medium VIP Glenoid Reamer, Univers VaultLock glenoid, large VIP Glenoid Reamer, Univers VaultLock glenoid, X-large	AR-5410-VLS AR-5410-VLM AR-5410-VLL AR-5410-VLXL
3	VIP Glenoid Reamer, Univers Revers™ MGS, 24 mm VIP Glenoid Reamer, Univers Revers MGS, 28 mm	AR-5410-24 AR-5410-28
4	VIP Glenoid Reamer, paleo	AR-5410-P
5	Glove Protector Sleeve	AR-9216-4
6	Modular Reamer Shaft	AR-9617

### Disposable Instruments

Product Description	Item Number
VIP Glenoid Reamer, Univers Revers Augmented MGS, small	AR-5410-AMGS-S
VIP Glenoid Reamer, Univers Revers Augmented MGS, medium	AR-5410-AMGS-M
VIP Glenoid Reamer, Univers Revers Augmented MGS, large	AR-5410-AMGS-L





# Knee Arthroplasty

Solutions for Partial and Total Knee Replacement

iBalance® UKA System.....	64
UKA Instrumentation Set 1 .....	67
UKA Instrumentation Set 2.....	71
iBalance® PFJ System.....	73
iBalance® PFJ.....	74
iBalance® TKA System .....	76
iBalance® TKA Set.....	82
Patellar Resection System .....	84
Instruments.....	85
Spacer Block Instrument Set.....	87
Tibial Stem and Augment Instrument Set.....	88
Ligament Balancing System Tray.....	90



### Unicondylar Knee Arthroplasty

- Only UKA implant that allows independent flexion and extension gap balancing
- Patented keel design resists anterior shear forces and anchors the tibial implants
- Tibial cortical support is preserved through all aspects of instrument fixation
- Independent control of flexion and extension space provide uncompromising joint line control, ligament balancing, bone preservation, and kinematic restoration
- Femoral thickness of 7 mm distal, posterior, and at midflexion
- Tibial thickness options range from 8 mm to 12 mm in 1 mm increments; 14 mm option also available
- Overall composite thickness between 15 mm and 21 mm



## iBalance® UKA System (Cont.)

### Implants

Product Description	Item Number
<b>Femoral Components</b>	
Femoral Component, size 1, LM	AR-501-UFLA
Femoral Component, size 2, LM	AR-501-UFLB
Femoral Component, size 3, LM	AR-501-UFLC
Femoral Component, size 4, LM	AR-501-UFLD
Femoral Component, size 5, LM	AR-501-UFLE
Femoral Component, size 6, LM	AR-501-UFLF
Femoral Component, size 1, RM	AR-501-UFRA
Femoral Component, size 2, RM	AR-501-UFRB
Femoral Component, size 3, RM	AR-501-UFRC
Femoral Component, size 4, RM	AR-501-UFRD
Femoral Component, size 5, RM	AR-501-UFRE
Femoral Component, size 6, RM	AR-501-UFRF
<b>Tibial Components</b>	
Tibial Tray Component, size 1, LM	AR-511-T1L
Tibial Tray Component, size 2, LM	AR-511-T2L
Tibial Tray Component, size 3, LM	AR-511-T3L
Tibial Tray Component, size 4, LM	AR-511-T4L
Tibial Tray Component, size 5, LM	AR-511-T5L
Tibial Tray Component, size 6, LM	AR-511-T6L
Tibial Tray Component, size 1, RM	AR-511-T1R
Tibial Tray Component, size 2, RM	AR-511-T2R
Tibial Tray Component, size 3, RM	AR-511-T3R
Tibial Tray Component, size 4, RM	AR-511-T4R
Tibial Tray Component, size 5, RM	AR-511-T5R
Tibial Tray Component, size 6, RM	AR-511-T6R
<b>Polyethylene Components</b>	
Tibial Bearing, size 1, 12 mm	AR-501-TBA2
Tibial Bearing, size 1, 14 mm	AR-501-TBA4
Tibial Bearing, size 2, 12 mm	AR-501-TBB2
Tibial Bearing, size 2, 14 mm	AR-501-TBB4
Tibial Bearing, size 3, 12 mm	AR-501-TBC2
Tibial Bearing, size 3, 14 mm	AR-501-TBC4
Tibial Bearing, size 4, 12 mm	AR-501-TBD2
Tibial Bearing, size 4, 14 mm	AR-501-TBD4
Tibial Bearing, size 5, 12 mm	AR-501-TBE2
Tibial Bearing, size 5, 14 mm	AR-501-TBE4
Tibial Bearing, size 6, 12 mm	AR-501-TBF2
Tibial Bearing, size 6, 14 mm	AR-501-TBF4

Product Description	Item Number
<b>Polyethylene Components, vit E</b>	
Tibial Bearing, size 1, 8 mm, vit E	AR-521-TBA8
Tibial Bearing, size 1, 9 mm, vit E	AR-521-TBA9
Tibial Bearing, size 1, 10 mm, vit E	AR-521-TBA0
Tibial Bearing, size 1, 11 mm, vit E	AR-521-TBA1
Tibial Bearing, size 1, 12 mm, vit E	AR-521-TBA2
Tibial Bearing, size 2, 8 mm, vit E	AR-521-TBB8
Tibial Bearing, size 2, 9 mm, vit E	AR-521-TBB9
Tibial Bearing, size 2, 10 mm, vit E	AR-521-TBB0
Tibial Bearing, size 2, 11 mm, vit E	AR-521-TBB1
Tibial Bearing, size 2, 12 mm, vit E	AR-521-TBB2
Tibial Bearing, size 3, 8 mm, vit E	AR-521-TBC8
Tibial Bearing, size 3, 9 mm, vit E	AR-521-TBC9
Tibial Bearing, size 3, 10 mm, vit E	AR-521-TBC0
Tibial Bearing, size 3, 11 mm, vit E	AR-521-TBC1
Tibial Bearing, size 3, 12 mm, vit E	AR-521-TBC2
Tibial Bearing, size 4, 8 mm, vit E	AR-521-TBD8
Tibial Bearing, size 4, 9 mm, vit E	AR-521-TBD9
Tibial Bearing, size 4, 10 mm, vit E	AR-521-TBD0
Tibial Bearing, size 4, 11 mm, vit E	AR-521-TBD1
Tibial Bearing, size 4, 12 mm, vit E	AR-521-TBD2
Tibial Bearing, size 5, 8 mm, vit E	AR-521-TBE8
Tibial Bearing, size 5, 9 mm, vit E	AR-521-TBE9
Tibial Bearing, size 5, 10 mm, vit E	AR-521-TBE0
Tibial Bearing, size 5, 11 mm, vit E	AR-521-TBE1
Tibial Bearing, size 5, 12 mm, vit E	AR-521-TBE2
Tibial Bearing, size 6, 8 mm, vit E	AR-521-TBF8
Tibial Bearing, size 6, 9 mm, vit E	AR-521-TBF9
Tibial Bearing, size 6, 10 mm, vit E	AR-521-TBF0
Tibial Bearing, size 6, 11 mm, vit E	AR-521-TBF1
Tibial Bearing, size 6, 12 mm, vit E	AR-521-TBF2

### Optional Instruments

Product Description	Item Number
Disposable Tibial Cutting Guide Left	AR-621-TL2
Disposable Tibial Cutting Guide Right	AR-621-TR2
iBalance UKA Tibial Fixation Buttress	AR-611-5
iBalance UKA Tibial Trialing Shim, 2/3 mm	AR-611-7
iBalance UKA Tibia Trialing Shim, 4/5 mm	AR-611-13
iBalance UKA Femoral Peg Drill, ø 0.312 mm	AR-601-FPDO
iBalance UKA Tibial Peg Drill, ø 0.312 mm	AR-601-TPDO
iBalance UKA Tibial Trial Handle	AR-611-18
EM Tibial Guide, long distal body	AR-623-32
Delta Scale Attachment	AR-611-21

## iBalance® UKA System (Cont.)

### Optional Spacer Block Organization (AR-611-SC1 and AR-611-SC2)

Product Description	Item Number	AR-611-SC1	AR-611-SC2
iBalance UKA Space Block Caddy, 11 spaces	AR-611-C3	✓	
iBalance UKA Space Block Caddy, 12 spaces	AR-611-C4		✓
iBalance UKA Spacer Block, 6 mm	AR-611-SB06	✓	
iBalance UKA Spacer Block, 7 mm	AR-611-SB07	✓	
iBalance UKA Spacer Block, 8 mm	AR-611-SB08	✓	✓
iBalance UKA Spacer Block, 9 mm	AR-611-SB09	✓	✓
iBalance UKA Spacer Block, 10 mm	AR-611-SB10	✓	✓
iBalance UKA Spacer Block, 11 mm	AR-611-SB11		✓
iBalance UKA Spacer Block, 12 mm	AR-611-SB12		✓
iBalance UKA Spacer Block, 14 mm	AR-611-SB14		✓
iBalance UKA Spacer Block, 15 mm	AR-611-SB15	✓	✓
iBalance UKA Spacer Block, 16 mm	AR-611-SB16	✓	✓
iBalance UKA Spacer Block, 17 mm	AR-611-SB17	✓	✓
iBalance UKA Spacer Block, 18 mm	AR-611-SB18	✓	✓
iBalance UKA Spacer Block, 19 mm	AR-611-SB19		✓
iBalance UKA Spacer Block, 21 mm	AR-611-SB21		✓

# UKA Instrumentation Set 1

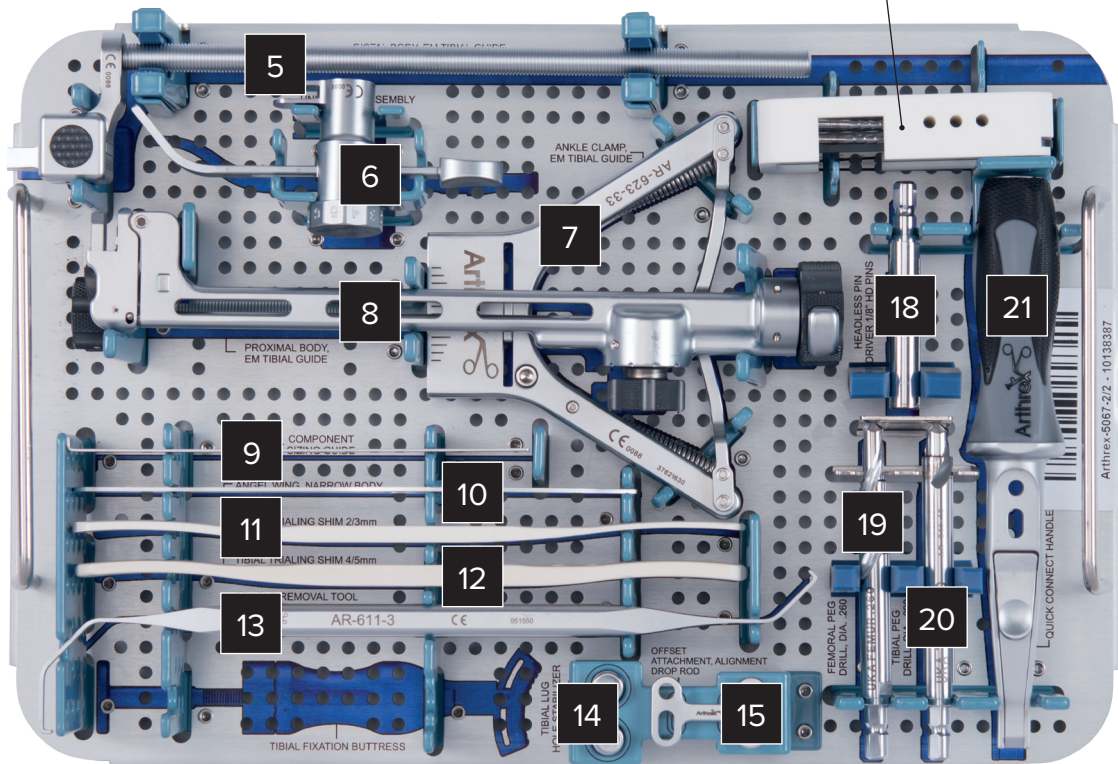

## UKA Instrumentation Set 1 (Cont.)

### UKA Instrumentation Set 1, Top Tray (AR-611-C1)

Label	Product Description	Item Number
1	iBalance® UKA Spacer Block, 6 mm	AR-611-SB06
	iBalance UKA Spacer Block, 7 mm	AR-611-SB07
	iBalance UKA Spacer Block, 8 mm	AR-611-SB08
	iBalance UKA Spacer Block, 9 mm	AR-611-SB09
	iBalance UKA Spacer Block, 10 mm	AR-611-SB10
	iBalance UKA Spacer Block, 15 mm	AR-611-SB15
	iBalance UKA Spacer Block, 16 mm	AR-611-SB16
	iBalance UKA Spacer Block, 17 mm	AR-611-SB17
	iBalance UKA Spacer Block, 18 mm	AR-611-SB18
2	iBalance UKA Modular Spacer Block, 5 mm	AR-611-SM05
	iBalance UKA Modular Spacer Block, 10 mm	AR-611-SM10
3	iBalance Patella Calipers	AR-602-48
4	iBalance UKA Quick-Connect Handle, short	AR-611-8
5	Short Distal Body, EM tibial guide	AR-623-31
6	UKA Tibial Stylus, adjustable	AR-611-17
7	Ankle Clamp EM Tibial Guide	AR-623-33
8	Proximal Body, EM tibial guide	AR-623-30
9	Tibia Measuring Guide	AR-611-14
10	Angel Wing, narrow body	AR-623-76
11	iBalance UKA Tibia Trialing Shim, 2/3 mm	AR-611-7
12	iBalance UKA Shim, 1/5 mm	AR-611-13
13	iBalance UKA Cement Removal Tool	AR-611-3
14	iBalance UKA Tibial Lug Hole Stabilizer	AR-611-12
15	iBalance UKA Offset Attachment Alignment, Drop Rod	AR-611-1
16	Threaded Pin, headed, short	AR-611-15
17	iBalance TKA Trocar Pin, Smooth	AR-613-50
18	iBalance UKA Headless Pin Driver	AR-613-91
19	iBalance UKA Femoral Peg Drill, Ø0.260	AR-611-11
20	iBalance UKA Tibia Peg Drill	AR-611-10
21	iBalance UKA Quick-Connect Handle, short	AR-611-8

## UKA Instrumentation Set 1 (Cont.)

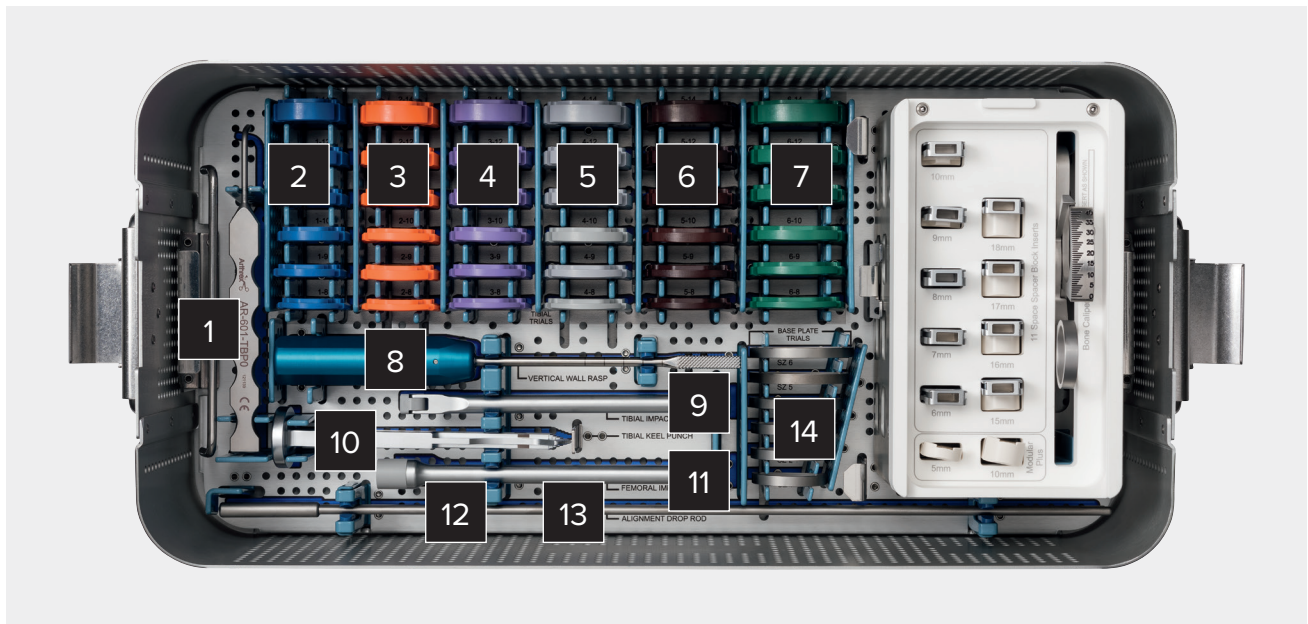

### UKA Instrumentation Set 1, Bottom Tray (AR-611-S1)

Label	Product Description	Item Number
1	iBalance® UKA, Trial Bearing Puller	AR-601-TBP0
2	iBalance UKA Tibial Bearing Trial, size 1, 10 mm iBalance UKA Tibial Bearing Trial, size 1, 11 mm iBalance UKA Tibial Bearing Trial, size 1, 12 mm iBalance UKA Tibial Bearing Trial, size 1, 14 mm iBalance UKA Tibial Bearing Trial, size 1, 8 mm iBalance UKA Tibial Bearing Trial, size 1, 9 mm	AR-601-TBA0 AR-601-TBA1 AR-601-TBA2 AR-601-TBA4 AR-601-TBA8 AR-601-TBA9
3	iBalance UKA Tibial Bearing Trial, size 2, 10 mm iBalance UKA Tibial Bearing Trial, size 2, 11 mm iBalance UKA Tibial Bearing Trial, size 2, 12 mm iBalance UKA Tibial Bearing Trial, size 2, 14 mm iBalance UKA Tibial Bearing Trial, size 2, 8 mm iBalance UKA Tibial Bearing Trial, size 2, 9 mm	AR-601-TBB0 AR-601-TBB1 AR-601-TBB2 AR-601-TBB4 AR-601-TBB8 AR-601-TBB9
4	iBalance UKA Tibial Bearing Trial, size 3, 10 mm iBalance UKA Tibial Bearing Trial, size 3, 11 mm iBalance UKA Tibial Bearing Trial, size 3, 12 mm iBalance UKA Tibial Bearing Trial, size 3, 14 mm iBalance UKA Tibial Bearing Trial, size 3, 8 mm iBalance UKA Tibial Bearing Trial, size 3, 9 mm	AR-601-TBC0 AR-601-TBC1 AR-601-TBC2 AR-601-TBC4 AR-601-TBC8 AR-601-TBC9
5	iBalance UKA Tibial Bearing Trial, size 4, 10 mm iBalance UKA Tibial Bearing Trial, size 4, 11 mm iBalance UKA Tibial Bearing Trial, size 4, 12 mm iBalance UKA Tibial Bearing Trial, size 4, 14 mm iBalance UKA Tibial Bearing Trial, size 4, 8 mm iBalance UKA Tibial Bearing Trial, size 4, 9 mm	AR-601-TBD0 AR-601-TBD1 AR-601-TBD2 AR-601-TBD4 AR-601-TBD8 AR-601-TBD9
6	iBalance UKA Tibial Bearing Trial, size 5, 10 mm iBalance UKA Tibial Bearing Trial, size 5, 11 mm iBalance UKA Tibial Bearing Trial, size 5, 12 mm iBalance UKA Tibial Bearing Trial, size 5, 14 mm iBalance UKA Tibial Bearing Trial, size 5, 8 mm iBalance UKA Tibial Bearing Trial, size 5, 9 mm	AR-601-TBE0 AR-601-TBE1 AR-601-TBE2 AR-601-TBE4 AR-601-TBE8 AR-601-TBE9

## UKA Instrumentation Set 1 (Cont.)

### UKA Instrumentation Set 1, Bottom Tray (AR-611-S1)

Label	Product Description	Item Number
7	iBalance® UKA Tibial Bearing Trial, size 6, 10 mm iBalance UKA Tibial Bearing Trial, size 6, 11 mm iBalance UKA Tibial Bearing Trial, size 6, 12 mm iBalance UKA Tibial Bearing Trial, size 6, 14 mm iBalance UKA Tibial Bearing Trial, size 6, 8 mm iBalance UKA Tibial Bearing Trial, size 6, 9 mm	AR-601-TBF0 AR-601-TBF1 AR-601-TBF2 AR-601-TBF4 AR-601-TBF8 AR-601-TBF9
8	Dilating Rasp, slot, meniscal allograft	AR-2963BR
9	iBalance UKA, femoral impactor	AR-611-6
10	iBalance UKA SportsPlasty™ Tibial Keel Punch	AR-611-9
11	iBalance UKA Tibial Impactor	AR-611-4
12	iBalance TKA Alignment Drop Rod w / Sleeve, 3/16 in × 18 in	AR-611-2
13	iBalance UKA, Alignment Rod, 3/16 in × 18 in	AR-601-AR00
14	iBalance UKA Base Plate, size 1 iBalance UKA Base Plate, size 2 iBalance UKA Base Plate, size 3 iBalance UKA Base Plate, size 4 iBalance UKA Base Plate, size 5 iBalance UKA Base Plate, size 6	AR-601-TBP1 AR-601-TBP2 AR-601-TBP3 AR-601-TBP4 AR-601-TBP5 AR-601-TBP6

## UKA Instrumentation Set 2

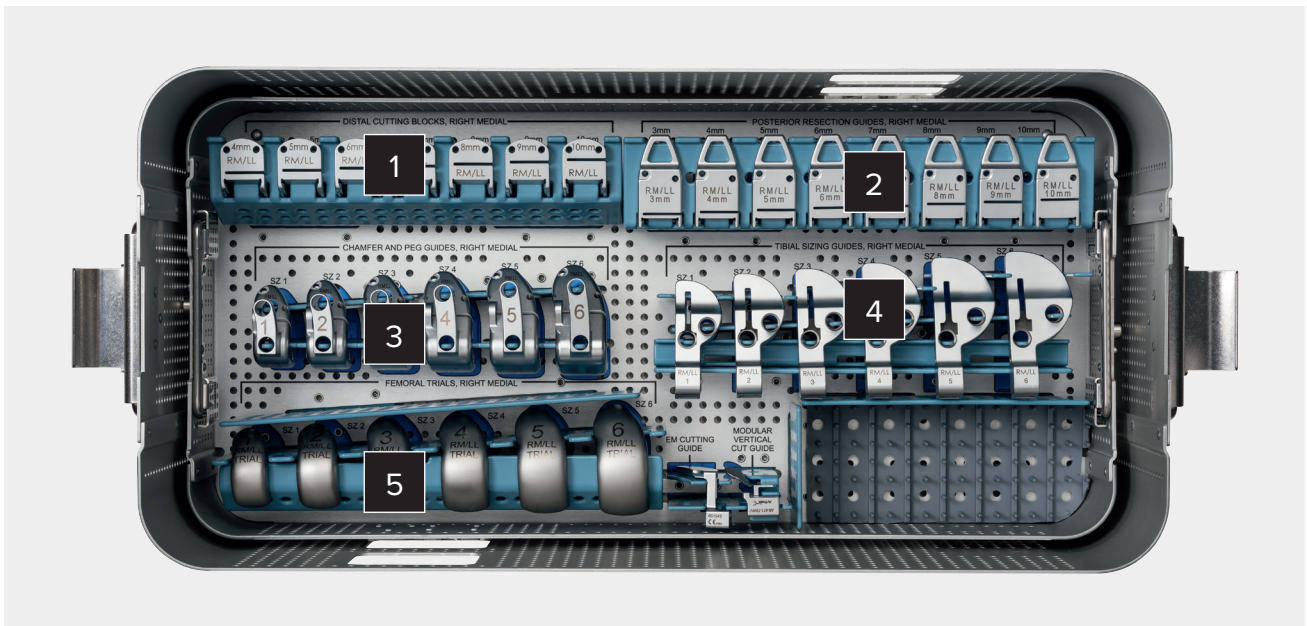

UKA Instrumentation Set 2, Right Medial Inner Tray (AR-611-C2R)

Label	Product Description	Item Number
1	iBalance® UKA RM/LL Distal Cut 4 mm Block iBalance UKA RM/LL Distal Cut 5 mm Block iBalance UKA RM/LL Distal Cut 6 mm Block iBalance UKA RM/LL Distal Cut 7 mm Block iBalance UKA RM/LL Distal Cut 8 mm Block iBalance UKA RM/LL Distal Cut 9 mm Block iBalance UKARM/LL Distal Cut 10 mm Block	AR-611-DR04 AR-611-DR05 AR-611-DR06 AR-611-DR07 AR-611-DR08 AR-611-DR09 AR-611-DR10
2	iBalance UKA RM/LL Post Cut 3 mm Block iBalance UKA RM/LL Post Cut 4 mm Block iBalance UKA RM/LL Post Cut 5 mm Block iBalance UKA RM/LL Post Cut 6 mm Block iBalance UKA RM/LL Post Cut 7 mm Block iBalance UKA RM/LL Post Cut 8 mm Block iBalance UKA RM/LL Post Cut 9 mm Block iBalance UKA RM/LL Post Cut 10 mm Block	AR-611-PR03 AR-611-PR04 AR-611-PR05 AR-611-PR06 AR-611-PR07 AR-611-PR08 AR-611-PR09 AR-611-PR10
3	iBalance UKA Femoral Finish Guide, size 1, RM/LL iBalance UKA Femoral Finish Guide, size 2, RM/LL iBalance UKA Femoral Finish Guide, size 3, RM/LL iBalance UKA Femoral Finish Guide, size 4, RM/LL iBalance UKA Femoral Finish Guide, size 5, RM/LL iBalance UKA Femoral Finish Guide, size 6, RM/LL	AR-611-CR1 AR-611-CR1 AR-611-CR3 AR-611-CR4 AR-611-CR5 AR-611-CR6
4	iBalance UKA RM/LL Tibial Finish Guide 1 iBalance UKA RM/LL Tibial Finish Guide 2 iBalance UKA RM/LL Tibial Finish Guide 3 iBalance UKA RM/LL Tibial Finish Guide 4 iBalance UKA RM/LL Tibial Finish Guide 5 iBalance UKA RM/LL Tibial Finish Guide 6	AR-611-TR1 AR-611-TR2 AR-611-TR3 AR-611-TR4 AR-611-TR5 AR-611-TR6
5	iBalance UKA Femoral Trial, size 1, RM/LL iBalance UKA Femoral Trial, size 2, RM/LL iBalance UKA Femoral Trial, size 3, RM/LL iBalance UKA Femoral Trial, size 4, RM/LL iBalance UKA Femoral Trial, size 5, RM/LL iBalance UKA Femoral Trial, size 6, RM/LL	AR-601-FTRA AR-601-FTRB AR-601-FTRC AR-601-FTRD AR-601-FTRE AR-601-FTRF

## UKA Instrumentation Set 2 (Cont.)

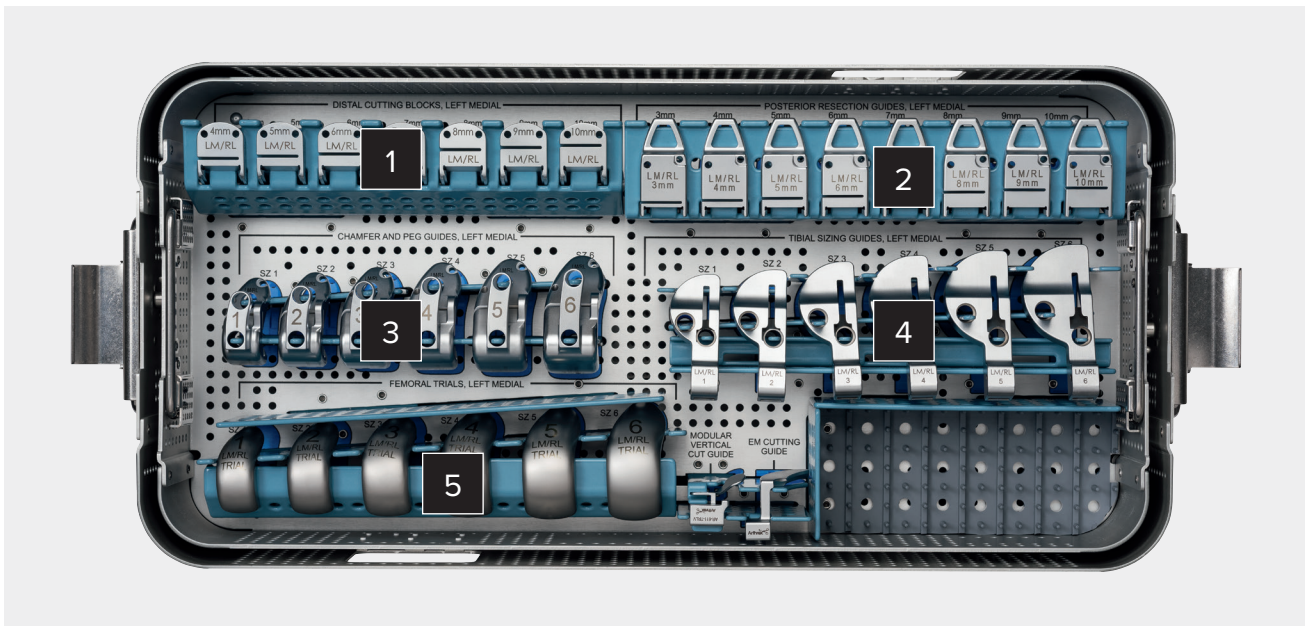

UKA Instrumentation Set 2, Left Medial Inner Tray (AR-611-C2L)

Label	Product Description	Item Number
1	iBalance® UKA LM/RL Distal Cut 4 mm Block iBalance UKA LM/RL Distal Cut 5 mm Block iBalance UKA LM/RL Distal Cut 6 mm Block iBalance UKA LM/RL Distal Cut 7 mm Block iBalance UKA LM/RL Distal Cut 8 mm Block iBalance UKA LM/RL Distal Cut 9 mm Block iBalance UKA LM/RL Distal Cut 10 mm Block	AR-611-DL04 AR-611-DL05 AR-611-DL06 AR-611-DL07 AR-611-DL08 AR-611-DL09 AR-611-DL10
2	iBalance UKA LM/RL Post Cut 3 mm Block iBalance UKA LM/RL Post Cut 4 mm Block iBalance UKA LM/RL Post Cut 5 mm Block iBalance UKA LM/RL Post Cut 6 mm Block iBalance UKA LM/RL Post Cut 7 mm Block iBalance UKA LM/RL Post Cut 8 mm Block iBalance UKA LM/RL Post Cut 9 mm Block iBalance UKA LM/RL Post Cut 10 mm Block	AR-611-PL03 AR-611-PL04 AR-611-PL05 AR-611-PL06 AR-611-PL07 AR-611-PL08 AR-611-PL09 AR-611-PL10
3	iBalance UKA Femoral Finish Guide, size 1 LM/RL iBalance UKA Femoral Finish Guide, size 2 LM/RL iBalance UKA Femoral Finish Guide, size 3 LM/RL iBalance UKA Femoral Finish Guide, size 4 LM/RL iBalance UKA Femoral Finish Guide, size 5 LM/RL iBalance UKA Femoral Finish Guide, size 6 LM/RL	AR-611-CL1 AR-611-CL2 AR-611-CL3 AR-611-CL4 AR-611-CL5 AR-611-CL6
4	iBalance UKA LM/RL Tibial Finish Guide 1 iBalance UKA LM/RL Tibial Finish Guide 2 iBalance UKA LM/RL Tibial Finish Guide 3 iBalance UKA LM/RL Tibial Finish Guide 4 iBalance UKA LM/RL Tibial Finish Guide 5 iBalance UKA LM/RL Tibial Finish Guide 6	AR-611-TL1 AR-611-TL2 AR-611-TL3 AR-611-TL4 AR-611-TL5 AR-611-TL6
5	iBalance UKA Femoral Trial, size 1, LM/RL iBalance UKA Femoral Trial, size 2, LM/RL iBalance UKA Femoral Trial, size 3, LM/RL iBalance UKA Femoral Trial, size 4, LM/RL iBalance UKA Femoral Trial, size 5, LM/RL iBalance UKA Femoral Trial, size 6, LM/RL	AR-601-FTLA AR-601-FTLB AR-601-FTLC AR-601-FTLD AR-601-FTLE AR-601-FTLF





### Patellofemoral Joint Arthroplasty

- Simplified onlay system with the benefits of trochlear inlay techniques
- Efficient, single-tray system designed for use in the ASC minimizes sterilization costs and turnover times and helps ensure predictable, reproducible patellofemoral arthroplasty procedures
- Precisely prepare the trochlea to match the underside geometry of the implant with the anterior femoral resection guide and captured jig
- Low-profile, anatomic trochlear implant—available in 4 sizes—articulates with a round dome, 3-peg patellar component

### Implants

Product Description	Item Number
<b>Trochlear Components</b>	
iBalance Patellofemoral Implant, left, size 1	AR-502-1L
iBalance Patellofemoral Implant, left, size 2	AR-502-2L
iBalance Patellofemoral Implant, left, size 3	AR-502-3L
iBalance Patellofemoral Implant, left, size 4	AR-502-4L
iBalance Patellofemoral Implant, right, size 1	AR-502-1R
iBalance Patellofemoral Implant, right, size 2	AR-502-2R
iBalance Patellofemoral Implant, right, size 3	AR-502-3R
iBalance patellofemoral Implant, right, size 4	AR-502-4R
<b>Patellar Components</b>	
iBalance Patella Implant Dome, 27 mm/8 mm	AR-504-PSA8
iBalance Patella Implant Dome, 30 mm/8 mm	AR-504-PSB8
iBalance Patella Implant Dome, 34 mm/9 mm	AR-504-PSC9
iBalance Patella Implant Dome, 37 mm/10 mm	AR-504-PSD0
iBalance Patella Implant Dome, 27 mm/8 mm, vit E	AR-524-PSA8
iBalance Patella Implant Dome, 30 mm/8 mm, vit E	AR-524-PSB8
iBalance Patella Implant Dome, 32 mm/8 mm, vit E	AR-524-PS328
iBalance Patella Implant Dome, 34 mm/9 mm, vit E	AR-524-PSC9
iBalance Patella Implant Dome, 37 mm/10 mm, vit E	AR-524-PSD0
iBalance Patella Implant Dome, 40 mm/10 mm, vit E	AR-524-PSE0

### iBalance PFJ Finishing Blades (Each kit includes 3 blades [distal, medial, and proximal])

Product Description	Item Number
Finishing Blades, size 1 mm	AR-602-26
Finishing Blades, size 2 mm	AR-602-27
Finishing Blades, size 3 mm	AR-602-28
Finishing Blades, size 4 mm	AR-602-29

# iBalance® PFJ

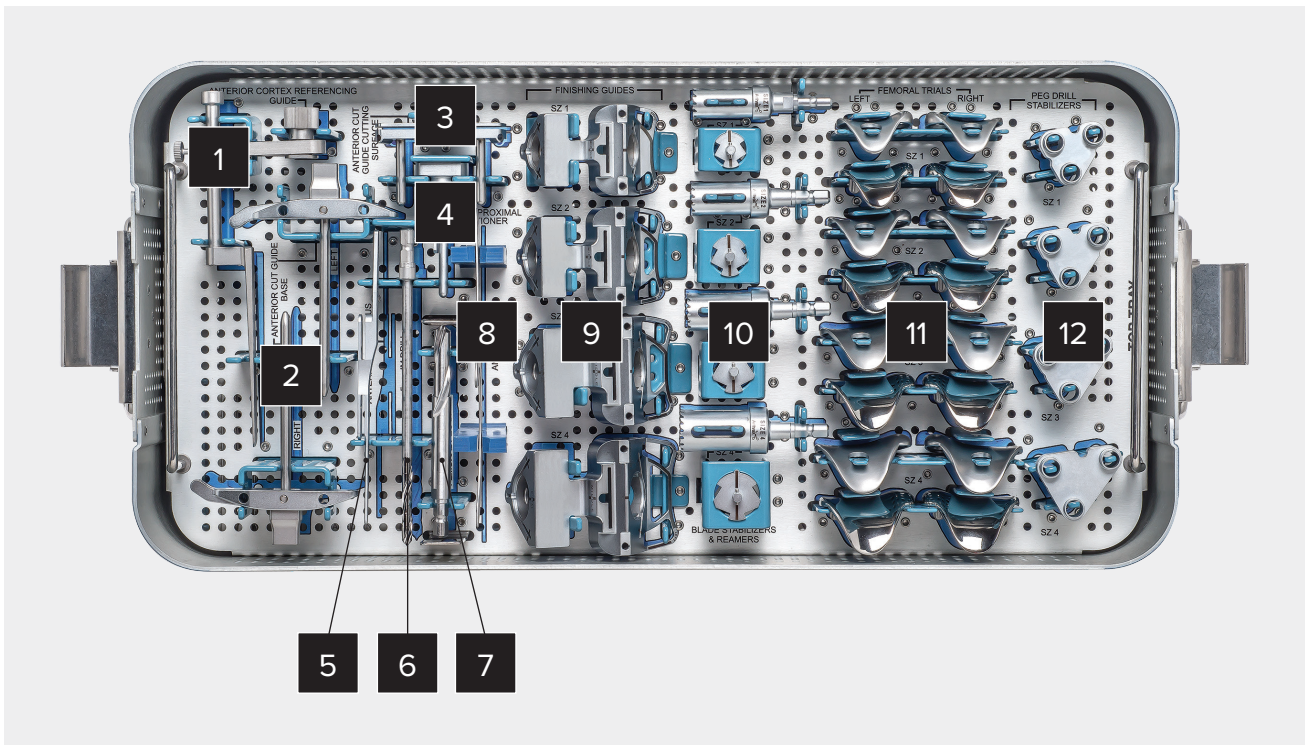

## iBalance PFJ, Top Tray (AR-602-S)

Label	Product Description	Item Number
1	Anterior Cortex Alignment Guide	AR-602-5
2	Anterior Cut Guide Base, left Anterior Cut Guide Base, right	AR-602-8L AR-602-8R
3	Anterior Cut Guide	AR-602-9
4	Distal/Proximal Stylus	AR-602-15
5	Anterior Cut Stylus	AR-602-10
6	IM Drill	AR-602-6
7	Femoral Peg Drill, Ø 0.312 in	AR-602-42
8	Angel Wing	AR-613-76
9	Finishing Guide, size 1 Finishing Guide, size 2 Finishing Guide, size 3 Finishing Guide, size 4	AR-602-11 AR-602-12 AR-602-13 AR-602-14
10	Trochlear Reamer, size 1 Trochlear Reamer, size 2 Trochlear Reamer, size 3 Trochlear Reamer, size 4 Blade Stabilizer, size 1 Blade Stabilizer, size 2 Blade Stabilizer, size 3 Blade Stabilizer, size 4	AR-602-16 AR-602-17 AR-602-18 AR-602-19 AR-602-20 AR-602-21 AR-602-22 AR-602-23

Label	Product Description	Item Number
11	iBalance Femoral Trial, size 1, left	AR-602-1L
	iBalance Femoral Trial, size 1, right	AR-602-1R
	iBalance Femoral Trial, size 2, left	AR-602-2L
	iBalance Femoral Trial, size 2, right	AR-602-2R
	iBalance Femoral Trial, size 3, left	AR-602-3L
	iBalance Femoral Trial, size 3, right	AR-602-3R
	iBalance Femoral Trial, size 4, left	AR-602-4L
	iBalance Femoral Trial, size 4, right	AR-602-4R
	iBalance PFJ Pegged Femoral Trial, size 1, left	AR-602-50
	iBalance PFJ Pegged Femoral Trial, size 2, left	AR-602-51
	iBalance PFJ Pegged Femoral Trial, size 3, left	AR-602-52
	iBalance PFJ Pegged Femoral Trial, size 4, left	AR-602-53
	iBalance PFJ Pegged Femoral Trial, size 1, right	AR-602-54
	iBalance PFJ Pegged Femoral Trial, size 2, right	AR-602-55
iBalance PFJ Pegged Femoral Trial, size 3, right	AR-602-56	
iBalance PFJ Pegged Femoral Trial, size 4, right	AR-602-57	
12	iBalance PFJ Pegged Drill Stabilizer, size 1	AR-602-38
	iBalance PFJ Pegged Drill Stabilizer, size 2	AR-602-39
	iBalance PFJ Pegged Drill Stabilizer, size 3	AR-602-40
	iBalance PFJ Pegged Drill Stabilizer, size 4	AR-602-41

## iBalance® PFJ (Cont.)

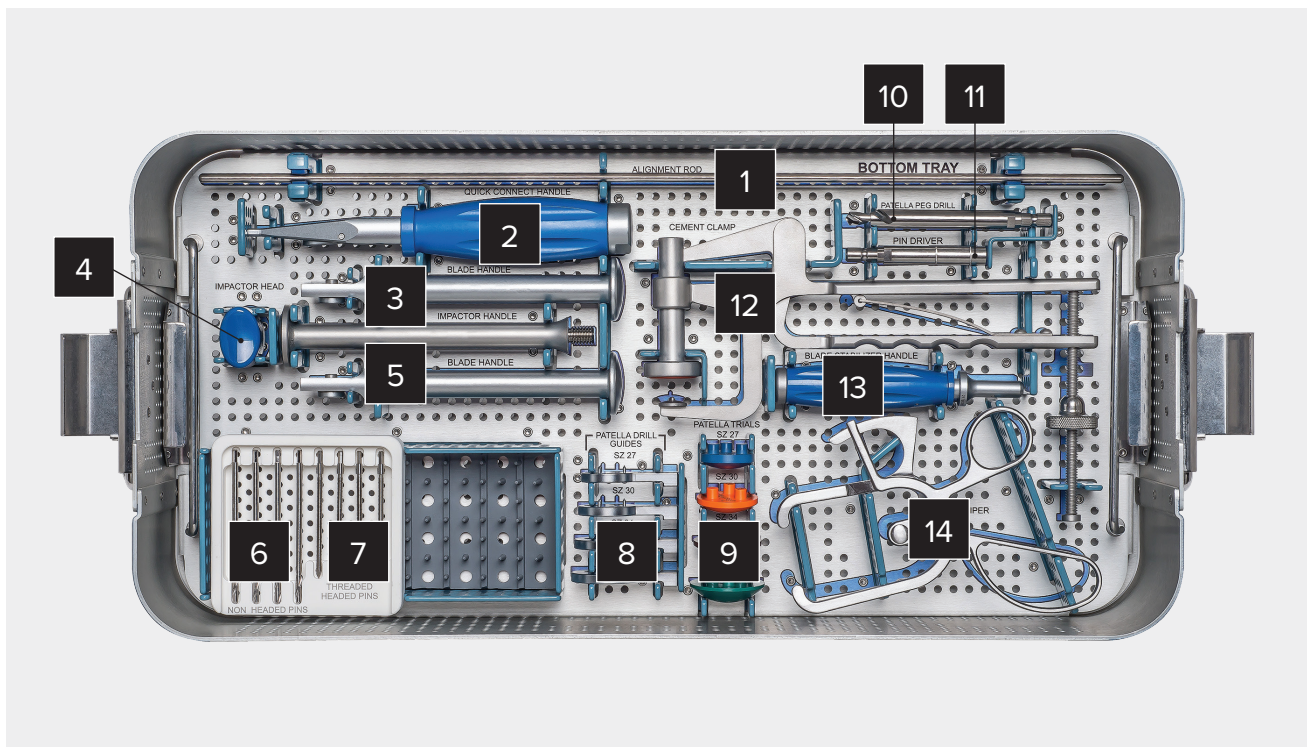

### iBalance PFJ, Bottom Tray (AR-602-S)

Label	Product Description	Item Number
1	iBalance UKA Alignment Rod, 3/16 in × 18 in	AR-601-AR00
2	iBalance Handle, quick connect	AR-613-8
3	iBalance PFJ Blade Handle	AR-602-25
4	iBalance PFJ Femoral Impactor Head	AR-602-43
5	iBalance TKA Universal Impactor Handle	AR-603-31
6	iBalance UKA Fixation Pin, 1/8 in × 3 in	AR-601-FP30
7	iBalance TKA Threaded Pin, headed	AR-603-72
8	iBalance Patella Drill Guide, 27 mm iBalance Patella Drill Guide, 30 mm iBalance Patella Drill Guide, 34 mm iBalance Patella Drill Guide, 37 mm	AR-602-44 AR-602-45 AR-602-46 AR-602-47
9	iBalance TKA Dome Patella Trial, size 27, 8 mm thick iBalance TKA Dome Patella Trial, size 30, 8 mm thick iBalance TKA Dome Patella Trial, size 34, 9 mm thick iBalance TKA Dome Patella Trial, size 37, 10 mm thick	AR-603-77 AR-603-79 AR-603-81 AR-603-83
10	iBalance TKA Patella Peg Drill, ø 0.0270 mm	AR-603-92
11	iBalance TKA Pin Driver	AR-613-91
12	iBalance TKA Patella Cement Clamp	AR-603-85
13	iBalance PFJ Blade Stabilizer Handler	AR-602-24
14	iBalance Patella Calipers	AR-602-48

### Not Pictured

Product Description	Item Number
iBalance PFJ Flexion Anterior Cut Guide	AR-602-58
iBalance TKA Dome Patella Trial, size 40, 10 mm thick	AR-603-84
iBalance Patella Drill Guide Combo	AR-602-49

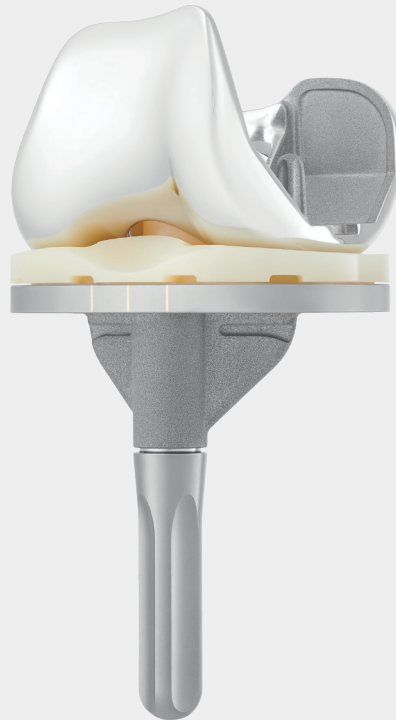

**Total Knee Arthroplasty**

- 8 mm distal and posterior thickness makes this the most bone-conserving TKA femoral component on the market
- Vitamin E-enriched advanced polyethylene provides proven wear reduction and resists oxidization<sup>8-10</sup>
- Optimized sizing ratio of the symmetric tibial baseplate allows for proper external rotation of the component without worry of posterolateral overhang
- Modular tibial stem attachment options coupled with medial and lateral tibial augments offer the flexibility to handle complex primary cases

## iBalance® TKA System (Cont.)

### Implants

Product Description	Item Number	Product Description	Item Number
<b>Tibial Trays</b>		<b>Tibial Bearings</b>	
iBalance TKA Modular Tibial Tray, size 1	AR-513-T1	CR+ Tibial Bearing, vit E, size 2, 8 mm	AR-523-A208
iBalance TKA Modular Tibial Tray, size 2	AR-513-T2	CR+ Tibial Bearing, vit E, size 2, 9 mm	AR-523-A209
iBalance TKA Modular Tibial Tray, size 3	AR-513-T3	CR+ Tibial Bearing, vit E, size 2, 10 mm	AR-523-A210
iBalance TKA Modular Tibial Tray, size 4	AR-513-T4	CR+ Tibial Bearing, vit E, size 2, 11 mm	AR-523-A211
iBalance TKA Modular Tibial Tray, size 5	AR-513-T5	CR+ Tibial Bearing, vit E, size 2, 12 mm	AR-523-A212
iBalance TKA Modular Tibial Tray, size 6	AR-513-T6	CR+ Tibial Bearing, vit E, size 2, 13 mm	AR-523-A213
iBalance TKA Modular Tibial Tray, size 7	AR-513-T7	CR+ Tibial Bearing, vit E, size 2, 14 mm	AR-523-A214
iBalance TKA Modular Tibial Tray, size 8	AR-513-T8	CR+ Tibial Bearing, vit E, size 3, 8 mm	AR-523-A308
iBalance TKA Modular Tibial Tray, size 9	AR-513-T9	CR+ Tibial Bearing, vit E, size 3, 9 mm	AR-523-A309
iBalance TKA Modular Tibial Tray, size 10	AR-513-T10	CR+ Tibial Bearing, vit E, size 3, 10 mm	AR-523-A310
<b>Femoral Implants</b>		CR+ Tibial Bearing, vit E, size 3, 11 mm	AR-523-A311
iBalance TKA Femoral Implant Cr, cemented size 1, left	AR-517-1L	CR+ Tibial Bearing, vit E, size 3, 12 mm	AR-523-A312
iBalance TKA Femoral Implant Cr, cemented size 1, right	AR-517-1R	CR+ Tibial Bearing, vit E, size 3, 13 mm	AR-523-A313
iBalance TKA Femoral Implant Cr, cemented size 2, left	AR-517-2L	CR+ Tibial Bearing, vit E, size 3, 14 mm	AR-523-A314
iBalance TKA Femoral Implant Cr, cemented size 2, right	AR-517-2R	CR+ Tibial Bearing, vit E, size 4, 8 mm	AR-523-A408
iBalance TKA Femoral Implant Cr, cemented size 3, left	AR-517-3L	CR+ Tibial Bearing, vit E, size 4, 9 mm	AR-523-A409
iBalance TKA Femoral Implant Cr, cemented size 3, right	AR-517-3R	CR+ Tibial Bearing, vit E, size 4, 10 mm	AR-523-A410
iBalance TKA Femoral Implant Cr, cemented size 4, left	AR-517-4L	CR+ Tibial Bearing, vit E, size 4, 11 mm	AR-523-A411
iBalance TKA Femoral Implant Cr, cemented size 4, right	AR-517-4R	CR+ Tibial Bearing, vit E, size 4, 12 mm	AR-523-A412
iBalance TKA Femoral Implant Cr, cemented size 5, left	AR-517-5L	CR+ Tibial Bearing, vit E, size 4, 13 mm	AR-523-A413
iBalance TKA Femoral Implant Cr, cemented size 5, right	AR-517-5R	CR+ Tibial Bearing, vit E, size 4, 14 mm	AR-523-A414
iBalance TKA Femoral Implant Cr, cemented size 6, left	AR-517-6L	CR+ Tibial Bearing, vit E, size 5, 8 mm	AR-523-A508
iBalance TKA Femoral Implant Cr, cemented size 6, right	AR-517-6R	CR+ Tibial Bearing, vit E, size 5, 9 mm	AR-523-A509
iBalance TKA Femoral Implant Cr, cemented size 7, left	AR-517-7L	CR+ Tibial Bearing, vit E, size 5, 10 mm	AR-523-A510
iBalance TKA Femoral Implant Cr, cemented size 7, right	AR-517-7R	CR+ Tibial Bearing, vit E, size 5, 11 mm	AR-523-A511
iBalance TKA Femoral Implant Cr, cemented size 8, left	AR-517-8L	CR+ Tibial Bearing, vit E, size 5, 12 mm	AR-523-A512
iBalance TKA Femoral Implant Cr, cemented size 8, right	AR-517-8R	CR+ Tibial Bearing, vit E, size 5, 13 mm	AR-523-A513
iBalance TKA Femoral Implant Cr, cemented size 9, left	AR-517-9L	CR+ Tibial Bearing, vit E, size 5, 14 mm	AR-523-A514
iBalance TKA Femoral Implant Cr, cemented size 9, right	AR-517-9R	CR+ Tibial Bearing, vit E, size 6, 8 mm	AR-523-A608
iBalance TKA Femoral Implant Cr, cemented size 10, left	AR-517-10L	CR+ Tibial Bearing, vit E, size 6, 9 mm	AR-523-A609
iBalance TKA Femoral Implant Cr, cemented size 10, right	AR-517-10R	CR+ Tibial Bearing, vit E, size 6, 10 mm	AR-523-A610
<b>Tibial Bearings</b>		CR+ Tibial Bearing, vit E, size 6, 11 mm	AR-523-A611
iBalance TKA Tibial Bearing Cr, size 1, 16 mm	AR-503-A116	CR+ Tibial Bearing, vit E, size 6, 12 mm	AR-523-A612
iBalance TKA Tibial Bearing Cr, size 1, 18 mm	AR-503-A118	CR+ Tibial Bearing, vit E, size 6, 13 mm	AR-523-A613
iBalance TKA Tibial Bearing Cr, size 2, 16 mm	AR-503-A216	CR+ Tibial Bearing, vit E, size 6, 14 mm	AR-523-A614
iBalance TKA Tibial Bearing Cr, size 2, 18 mm	AR-503-A218	CR+ Tibial Bearing, vit E, size 7, 8 mm	AR-523-A708
iBalance TKA Tibial Bearing Cr, size 3, 16 mm	AR-503-A316	CR+ Tibial Bearing, vit E, size 7, 9 mm	AR-523-A709
iBalance TKA Tibial Bearing Cr, size 3, 18 mm	AR-503-A318	CR+ Tibial Bearing, vit E, size 7, 10 mm	AR-523-A710
iBalance TKA Tibial Bearing Cr, size 4, 16 mm	AR-503-A416	CR+ Tibial Bearing, vit E, size 7, 11 mm	AR-523-A711
iBalance TKA Tibial Bearing Cr, size 4, 18 mm	AR-503-A418	CR+ Tibial Bearing, vit E, size 7, 12 mm	AR-523-A712
iBalance TKA Tibial Bearing Cr, size 5, 16 mm	AR-503-A516	CR+ Tibial Bearing, vit E, size 7, 13 mm	AR-523-A713
iBalance TKA Tibial Bearing Cr, size 5, 18 mm	AR-503-A518	CR+ Tibial Bearing, vit E, size 7, 14 mm	AR-523-A714
iBalance TKA Tibial Bearing Cr, size 6, 16 mm	AR-503-A616	CR+ Tibial Bearing, vit E, size 8, 8 mm	AR-523-A808
iBalance TKA Tibial Bearing Cr, size 6, 18 mm	AR-503-A618	CR+ Tibial Bearing, vit E, size 8, 9 mm	AR-523-A809
iBalance TKA Tibial Bearing Cr, size 7, 16 mm	AR-503-A716	CR+ Tibial Bearing, vit E, size 8, 10 mm	AR-523-A810
iBalance TKA Tibial Bearing Cr, size 7, 18 mm	AR-503-A718	CR+ Tibial Bearing, vit E, size 8, 11 mm	AR-523-A811
iBalance TKA Tibial Bearing Cr, size 8, 16 mm	AR-503-A816	CR+ Tibial Bearing, vit E, size 8, 12 mm	AR-523-A812
iBalance TKA Tibial Bearing Cr, size 8, 18 mm	AR-503-A818	CR+ Tibial Bearing, vit E, size 8, 13 mm	AR-523-A813
iBalance TKA Tibial Bearing Cr, size 9, 16 mm	AR-503-A916	CR+ Tibial Bearing, vit E, size 8, 14 mm	AR-523-A814
iBalance TKA Tibial Bearing Cr, size 9, 18 mm	AR-503-A918	CR+ Tibial Bearing, vit E, size 9, 8 mm	AR-523-A908
iBalance TKA Tibial Bearing Cr, size 10, 16 mm	AR-503-A1016	CR+ Tibial Bearing, vit E, size 9, 9 mm	AR-523-A909
iBalance TKA Tibial Bearing Cr, size 10, 18 mm	AR-503-A1018	CR+ Tibial Bearing, vit E, size 9, 10 mm	AR-523-A910
CR+ Tibial Bearing, vit E, size 1, 8 mm	AR-523-A108	CR+ Tibial Bearing, vit E, size 9, 11 mm	AR-523-A911
CR+ Tibial Bearing, vit E, size 1, 9 mm	AR-523-A109	CR+ Tibial Bearing, vit E, size 9, 12 mm	AR-523-A912
CR+ Tibial Bearing, vit E, size 1, 10 mm	AR-523-A110	CR+ Tibial Bearing, vit E, size 9, 13 mm	AR-523-A913
CR+ Tibial Bearing, vit E, size 1, 11 mm	AR-523-A111	CR+ Tibial Bearing, vit E, size 9, 14 mm	AR-523-A914
CR+ Tibial Bearing, vit E, size 1, 12 mm	AR-523-A112		
CR+ Tibial Bearing, vit E, size 1, 13 mm	AR-523-A113		
CR+ Tibial Bearing, vit E, size 1, 14 mm	AR-523-A114		

## iBalance® TKA System (Cont.)

### Implants

Product Description	Item Number
<b>Tibial Bearings</b>	
CR+ Tibial Bearing, vit E, size 9, 13 mm	AR-523-A913
CR+ Tibial Bearing, vit E, size 9, 14 mm	AR-523-A914
CR+ Tibial Bearing, vit E, size 10, 8 mm	AR-523-A1008
CR+ Tibial Bearing, vit E, size 10, 9 mm	AR-523-A1009
CR+ Tibial Bearing, vit E, size 10, 10 mm	AR-523-A1010
CR+ Tibial Bearing, vit E, size 10, 11 mm	AR-523-A1011
CR+ Tibial Bearing, vit E, size 10, 12 mm	AR-523-A1012
CR+ Tibial Bearing, vit E, size 10, 13 mm	AR-523-A1013
CR+ Tibial Bearing, vit E, size 10, 14 mm	AR-523-A1014
<b>iBalance PS Femurs</b>	
iBalance TKA Femoral Implant PS, cemented, size 1, left	AR-526-1L
iBalance TKA Femoral Implant PS, cemented, size 1, right	AR-526-1R
iBalance TKA Femoral Implant PS, cemented, size 2, left	AR-526-2L
iBalance TKA Femoral Implant PS, cemented, size 2, right	AR-526-2R
iBalance TKA Femoral Implant PS, cemented, size 3, left	AR-526-3L
iBalance TKA Femoral Implant PS, cemented, size 3, right	AR-526-3R
iBalance TKA Femoral Implant PS, cemented, size 4, left	AR-526-4L
iBalance TKA Femoral Implant PS, cemented, size 4, right	AR-526-4R
iBalance TKA Femoral Implant PS, cemented, size 5, left	AR-526-5L
iBalance TKA Femoral Implant PS, cemented, size 5, right	AR-526-5R
iBalance TKA Femoral Implant PS, cemented, size 6, left	AR-526-6L
iBalance TKA Femoral Implant PS, cemented, size 6, right	AR-526-6R
iBalance TKA Femoral Implant PS, cemented, size 7, left	AR-526-7L
iBalance TKA Femoral Implant PS, cemented, size 7, right	AR-526-7R
iBalance TKA Femoral Implant PS, cemented, size 8, left	AR-526-8L
iBalance TKA Femoral Implant PS, cemented, size 8, right	AR-526-8R
iBalance TKA Femoral Implant PS, cemented, size 9, left	AR-526-9L
iBalance TKA Femoral Implant PS, cemented, size 9, right	AR-526-9R
iBalance TKA Femoral Implant PS, cemented, size 10, left	AR-526-10L
iBalance TKA Femoral Implant PS, Cemented size 10, right	AR-526-10R
<b>iBalance TKA Stems</b>	
iBalance TKA Tibial Stems, 10 mm × 50 mm	AR-513-1050
iBalance TKA Tibial Stems, 12 mm × 50 mm	AR-513-1250
iBalance TKA Tibial Stems, 14 mm × 50 mm	AR-513-1450
iBalance TKA Tibial Stems, 10 mm × 100 mm	AR-513-10100
iBalance TKA Tibial Stems, 12 mm × 100 mm	AR-513-12100
iBalance TKA Tibial Stems, 14 mm × 100 mm	AR-513-14100

Product Description	Item Number
<b>iBalance TKA Augments</b>	
iBalance TKA Tibial Augments, size 1, 5 mm RM/LL	AR-513-RM15
iBalance TKA Tibial Augments, size 1, 5 mm LM/RL	AR-513-RL15
iBalance TKA Tibial Augments, size 1, 10 mm RM/LL	AR-513-RM110
iBalance TKA Tibial Augments, size 1, 10 mm LM/RL	AR-513-RL110
iBalance TKA Tibial Augments, size 2, 5 mm RM/LL	AR-513-RM25
iBalance TKA Tibial Augments, size 2, 5 mm LM/RL	AR-513-RL25
iBalance TKA Tibial Augments, size 2, 10 mm RM/LL	AR-513-RM210
iBalance TKA Tibial Augments, size 2, 10 mm LM/RL	AR-513-RL210
iBalance TKA Tibial Augments, size 3, 5 mm RM/LL	AR-513-RM35
iBalance TKA Tibial Augments, size 3, 5 mm LM/RL	AR-513-RL35
iBalance TKA Tibial Augments, size 3, 10 mm RM/LL	AR-513-RM310
iBalance TKA Tibial Augments, size 3, 10 mm LM/RL	AR-513-RL310
iBalance TKA Tibial Augments, size 4, 5 mm RM/LL	AR-513-RM45
iBalance TKA Tibial Augments, size 4, 5 mm LM/RL	AR-513-RL45
iBalance TKA Tibial Augments, size 4, 10 mm RM/LL	AR-513-RM410
iBalance TKA Tibial Augments, size 4, 10 mm LM/RL	AR-513-RL410
iBalance TKA Tibial Augments, size 5, 5 mm RM/LL	AR-513-RM55
iBalance TKA Tibial Augments, size 5, 5 mm LM/RL	AR-513-RL55
iBalance TKA Tibial Augments, size 5, 10 mm RM/LL	AR-513-RM510
iBalance TKA Tibial Augments, size 5, 10 mm LM/RL	AR-513-RL510
iBalance TKA Tibial Augments, size 6, 5 mm RM/LL	AR-513-RM65
iBalance TKA Tibial Augments, size 6, 5 mm LM/RL	AR-513-RL65
iBalance TKA Tibial Augments, size 6, 10 mm RM/LL	AR-513-RM610
iBalance TKA Tibial Augments, size 6, 10 mm LM/RL	AR-513-RL610
iBalance TKA Tibial Augments, size 7, 5 mm RM/LL	AR-513-RM75
iBalance TKA Tibial Augments, size 7, 5 mm LM/RL	AR-513-RL75
iBalance TKA Tibial Augments, size 7, 10 mm RM/LL	AR-513-RM710
iBalance TKA Tibial Augments, size 7, 10 mm LM/RL	AR-513-RL710
iBalance TKA Tibial Augments, size 8, 5 mm RM/LL	AR-513-RM85
iBalance TKA Tibial Augments, size 8, 5 mm LM/RL	AR-513-RL85
iBalance TKA Tibial Augments, size 8, 10 mm RM/LL	AR-513-RM810
iBalance TKA Tibial Augments, size 8, 10 mm LM/RL	AR-513-RL810
iBalance TKA Tibial Augments, size 9, 5 mm RM/LL	AR-513-RM95
iBalance TKA Tibial Augments, size 9, 5 mm LM/RL	AR-513-RL95
iBalance TKA Tibial Augments, size 9, 10 mm RM/LL	AR-513-RM910
iBalance TKA Tibial Augments, size 9, 10 mm LM/RL	AR-513-RL910
iBalance TKA Tibial Augments, size 10, 5 mm RM/LL	AR-513-RM105
iBalance TKA Tibial Augments, size 10, 5 mm LM/RL	AR-513-RL105
iBalance TKA Tibial Augments, size 10, 10 mm RM/LL	AR-513-RM1010
iBalance TKA Tibial Augments, size 10, 10 mm LM/RL	AR-513-RL1010
<b>iBalance TKA CR+ Vitamin E Bearings</b>	
iBalance TKA CR+ Tibial Bearing, vit E, size 1, 16 mm	AR-523-A116
iBalance TKA CR+ Tibial Bearing, vit E, size 1, 18 mm	AR-523-A118
iBalance TKA CR+ Tibial Bearing, vit E, size 2, 16 mm	AR-523-A216
iBalance TKA CR+ Tibial Bearing, vit E, size 2, 18 mm	AR-523-A218
iBalance TKA CR+ Tibial Bearing, vit E, size 3, 16 mm	AR-523-A316
iBalance TKA CR+ Tibial Bearing, vit E, size 3, 18 mm	AR-523-A318
iBalance TKA CR+ Tibial Bearing, vit E, size 4, 16 mm	AR-523-A416
iBalance TKA CR+ Tibial Bearing, vit E, size 4, 18 mm	AR-523-A418









## iBalance® TKA Set

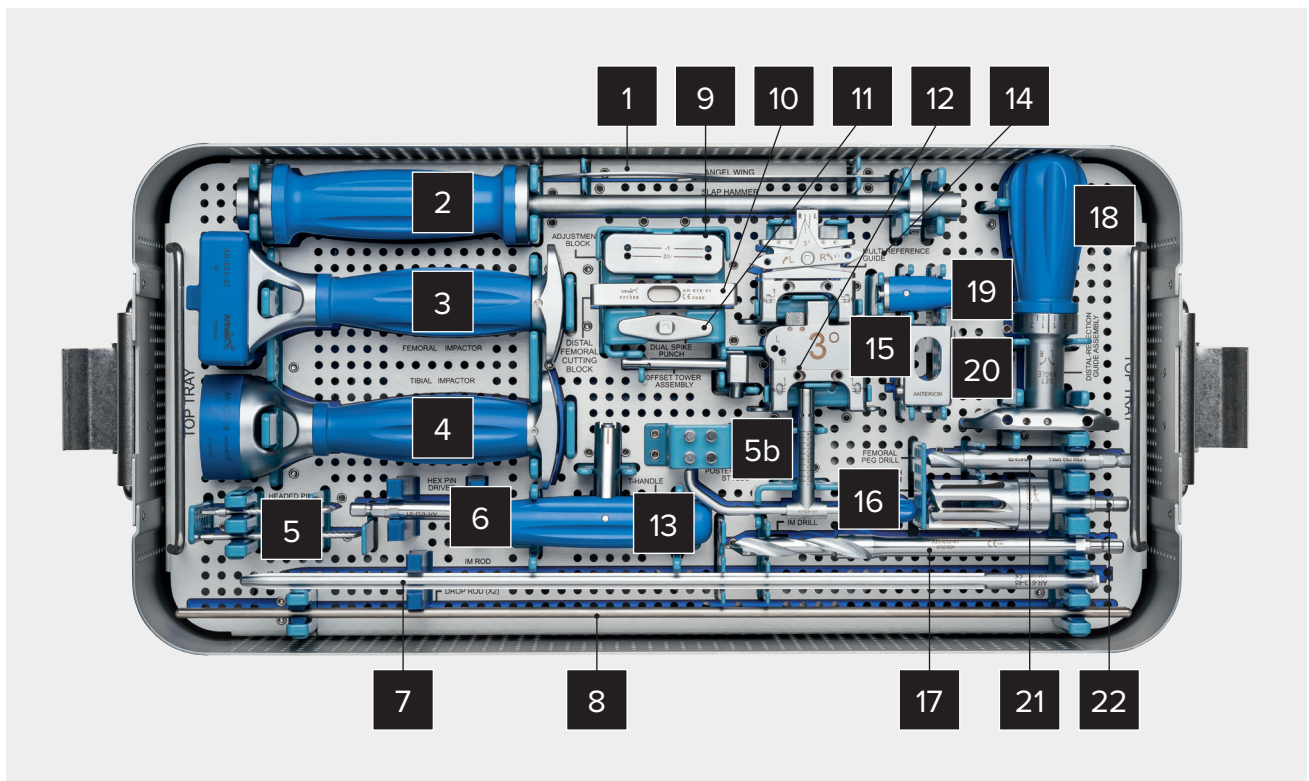

### iBalance TKA Set, Top Tray (AR-613-S)

Label	Product Description	Item Number
1	Angel Wing, narrow body	AR-623-76
2	Slap Hammer	AR-613-99
3	Femoral Impactor, solid handle	AR-623-37
4	Tibial Impactor, solid handle	AR-623-36
5	Headed Threaded Pin	AR-603-72
5b	Double-Headed Pin, 1 in	AR-603-7
6	Pin Driver	AR-613-91
7	IM Rod, modular	AR-613-45
8	Alignment Drop Rod w/ Sleeve, 3/16 in × 18 in	AR-611-2
9	Femoral Anterior Adjustment Block	AR-613-47
10	Distal Femoral Resection Guide	AR-613-44
11	Femoral Dual Spike Punch	AR-613-65
12	Femoral Offset Tower	AR-613-43
13	Modular T-Handle	AR-613-48
14	Femoral Sizer, 0° to 7°	AR-623-63
15	Femoral Sizer, 3°	AR-623-61
16	Femoral Sizing Stylus	AR-613-24
17	IM Drill	AR-613-41
18	Femoral Alignment Guide	AR-613-42
19	Small Impactor	AR-613-98
20	Femoral Notch Chisel	AR-613-69
21	Femoral Peg Drill	AR-613-70
22	Femoral Notch Reamer	AR-603-73

## iBalance® TKA Set (Cont.)

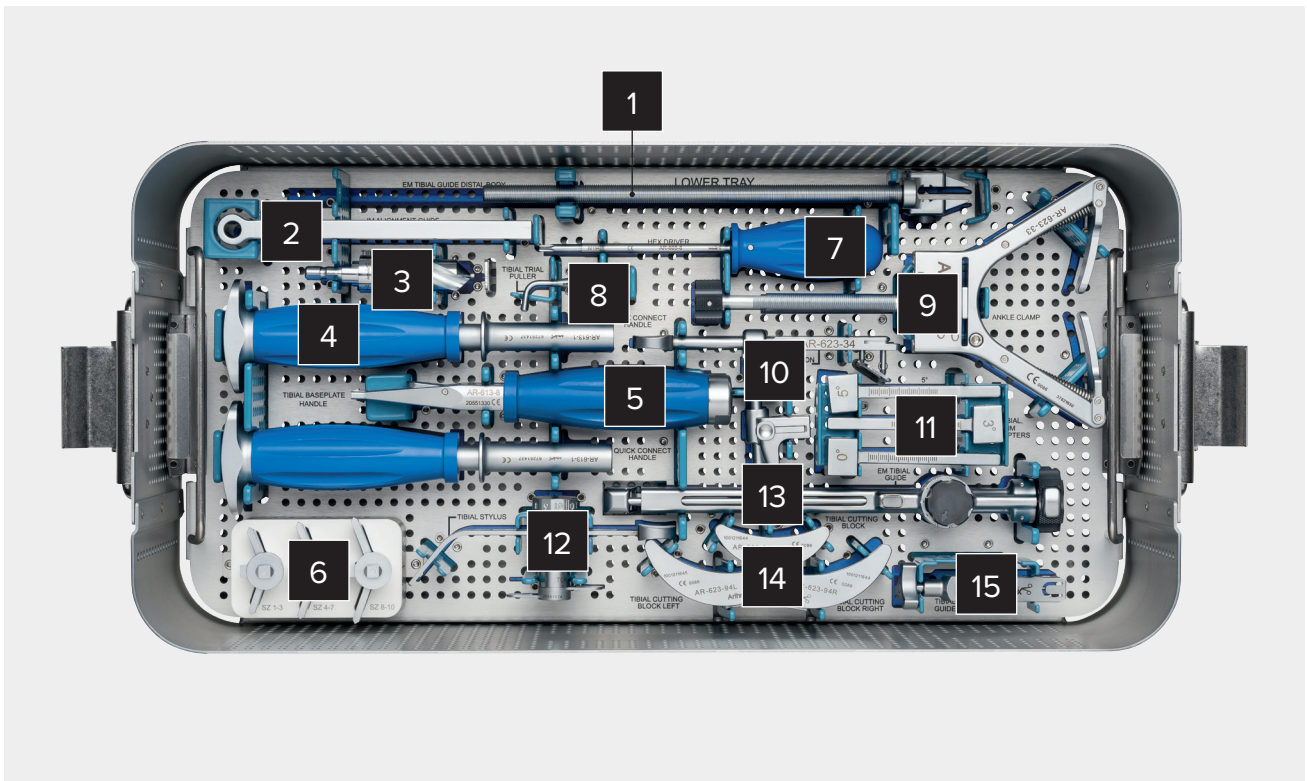

### iBalance TKA Set, Bottom Tray (AR-613-S)

Label	Product Description	Item Number
1	Short Distal Body, EM tibial	AR-623-31
2	IM Alignment Handle	AR-613-10
3	Post Drill	AR-623-4
4	Modular Keel Punch Handle	AR-613-1
5	Quick-Connect Handle	AR-613-8
6	Keel Punch, size 1-3 Keel Punch, size 4-7 Keel Punch, size 8-10	AR-623-5 AR-623-6 AR-623-7
7	T20 Hex Driver	AR-605-8
8	Tibial Trial Puller	AR-613-22
9	Ankle Clamp	AR-623-33
10	EM Fixation Spike (optional)	AR-623-34
11	IM Tibial Adaptor, 0° IM Tibial Adaptor, 3° IM Tibial Adaptor, 5°	AR-613-11 AR-613-12 AR-613-13
12	Tibial Stylus, adjustable	AR-623-35
13	EM Tibial Guide, proximal body	AR-623-30
14	Tibial Cut Block, midline Tibial Cut Block, left Tibial Cut Block, right	AR-623-94 AR-623-94L AR-623-94R
15	Resection Guide Connector, tibial	AR-623-38

## Patellar Resection System

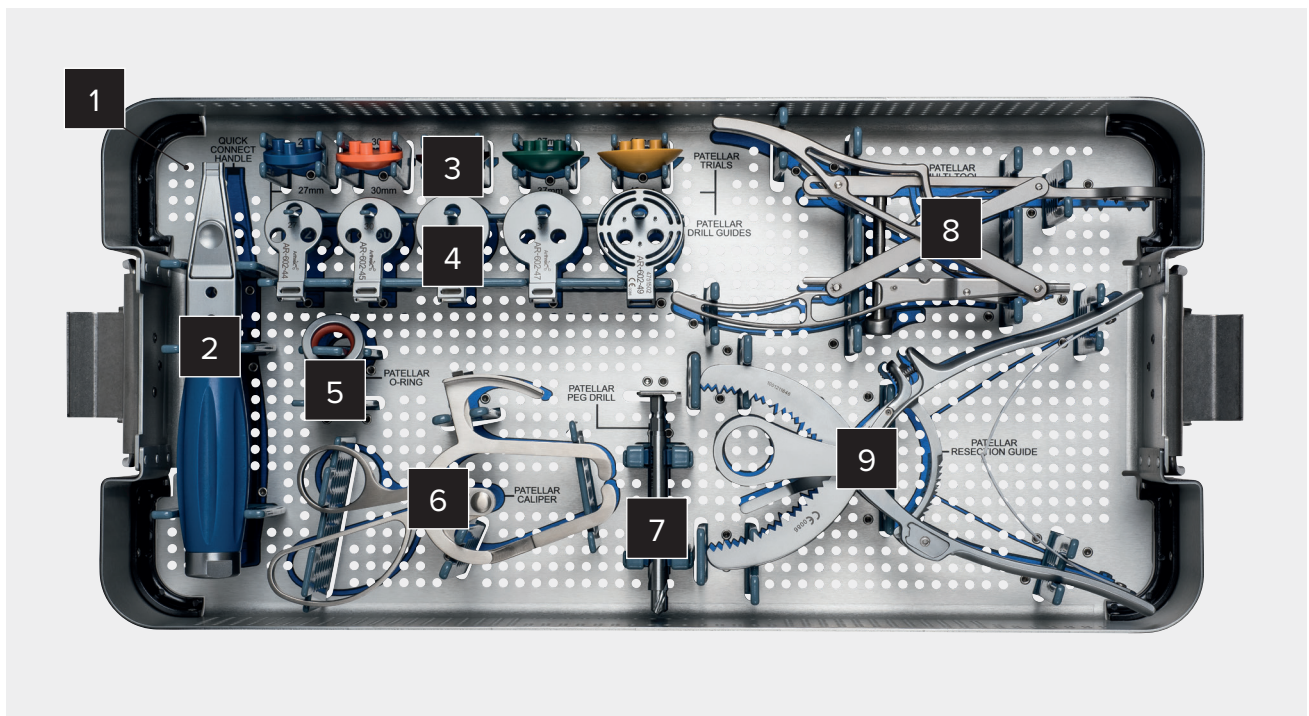

### Patellar Resection System (AR-612-S)

Label	Product Description	Item Number
1	Patella Resection Instrument Case	AR-612-C1
2	Quick-Connect Handle	AR-613-8
3	Patella Trial, 34 mm Patella Trial, 34 mm Patella Trial, 34 mm Patella Trial, 37 mm Patella Trial, 40 mm	AR-603-77 AR-603-79 AR-603-81 AR-603-83 AR-603-84
4	Patella Drill Guide, 27 mm Patella Drill Guide, 30 mm Patella Drill Guide, 34 mm Patella Drill Guide, 37 mm Patella Drill Guide, 40 mm	AR-602-44 AR-602-44 AR-602-46 AR-602-47 AR-602-49
5	O-ring Attachment	AR-613-95
6	Patella Calipers	AR-602-48
7	Patella Peg Drill	AR-603-92
8	Patella Multitool	AR-613-93
9	Patella Resection Guide	AR-612-19

## Instruments

### Patellar Reaming Instrument Set (AR-612-SR)

Product Description	Item Number
Patellar Reamer Instrument Case	AR-612-C2
Patella Reamer Planer Guide, 27 mm	AR-612-4
Patella Reamer Planer Guide, 30 mm	AR-612-5
Patella Reamer Planer Guide, 34 mm	AR-612-6
Patella Reamer Planer Guide, 37 mm	AR-612-7
Patella Reamer Planer Guide, 40 mm	AR-612-8
Patella Reamer Lug Prep, 27 mm	AR-612-14
Patella Reamer Lug Prep, 30 mm	AR-612-15
Patella Reamer Lug Prep, 34 mm	AR-612-16
Patella Reamer Lug Prep, 37 mm	AR-612-17
Patella Reamer Lug Prep, 40 mm	AR-612-18
Patella Reamer Cement Insert	AR-612-3
Patella Peg Drill	AR-603-92
Patella Trial, 27 mm	AR-603-77
Patella Trial, 30 mm	AR-603-79
Patella Trial, 34 mm	AR-603-81
Patella Trial, 37 mm	AR-603-83
Patella Trial, 40 mm	AR-603-84
Patella Reamer Planer, 27 mm	AR-612-9
Patella Reamer Planer, 30 mm	AR-612-10
Patella Reamer Planer, 34 mm	AR-612-11
Patella Reamer Planer, 37 mm	AR-612-12
Patella Reamer Planer, 40 mm	AR-612-13
Patellar Reamer Clamp	AR-612-1
Patella Calipers	AR-602-48
Patellar Drill Guide, 27 mm	AR-602-44
Patellar Drill Guide, 30 mm	AR-602-45
Patellar Drill Guide, 34 mm	AR-602-46
Patellar Drill Guide, 37 mm	AR-602-47
Patellar Drill Guide, 40 mm	AR-602-49
Patella Reamer, planer body	AR-612-2



### Size 1-10 Instrument Sets

Product Description	Item Number
Left Femoral Trial, size 1	AR-613-1L
Left Femoral Trial, size 2	AR-613-2L
Left Femoral Trial, size 3	AR-613-3L
Left Femoral Trial, size 4	AR-613-4L
Left Femoral Trial, size 5	AR-613-5L
Left Femoral Trial, size 6	AR-613-6L
Left Femoral Trial, size 7	AR-613-7L
Left Femoral Trial, size 8	AR-613-8L
Left Femoral Trial, size 9	AR-613-9L
Left Femoral Trial, size 10	AR-613-10L
Right Femoral Trial, size 1	AR-613-1R
Right Femoral Trial, size 2	AR-613-2R
Right Femoral Trial, size 3	AR-613-3R
Right Femoral Trial, size 4	AR-613-4R
Right Femoral Trial, size 5	AR-613-5R
Right Femoral Trial, size 6	AR-613-6R
Right Femoral Trial, size 7	AR-613-7R
Right Femoral Trial, size 8	AR-613-8R
Right Femoral Trial, size 9	AR-613-9R
Right Femoral Trial, size 10	AR-613-10R
Femoral Cutting Block, size 1	AR-623-51
Femoral Cutting Block, size 2	AR-623-52
Femoral Cutting Block, size 3	AR-623-53
Femoral Cutting Block, size 4	AR-623-54
Femoral Cutting Block, size 5	AR-623-55
Femoral Cutting Block, size 6	AR-623-56
Femoral Cutting Block, size 7	AR-623-57
Femoral Cutting Block, size 8	AR-623-58
Femoral Cutting Block, size 9	AR-623-59
Femoral Cutting Block, size 10	AR-623-60
Notch Prep Guide, size 1	AR-613-101
Notch Prep Guide, size 2	AR-613-102
Notch Prep Guide, size 3	AR-613-103
Notch Prep Guide, size 4	AR-613-104
Notch Prep Guide, size 5	AR-613-105
Notch Prep Guide, size 6	AR-613-106
Notch Prep Guide, size 7	AR-613-107
Notch Prep Guide, size 8	AR-613-108
Notch Prep Guide, size 9	AR-613-109
Notch Prep Guide, size 10	AR-613-110
PS Femoral Trial Modular Crossbar	AR-613-74
Modular PS Post Trial	AR-613-26

## Instruments (Cont.)

Product Description	Item Number
Tibial Baseplate Trial, size 1	AR-623-T1
Tibial Baseplate Trial, size 2	AR-623-T2
Tibial Baseplate Trial, size 3	AR-623-T3
Tibial Baseplate Trial, size 4	AR-623-T4
Tibial Baseplate Trial, size 5	AR-623-T5
Tibial Baseplate Trial, size 6	AR-623-T6
Tibial Baseplate Trial, size 7	AR-623-T7
Tibial Baseplate Trial, size 8	AR-623-T8
Tibial Baseplate Trial, size 9	AR-623-99
Tibial Baseplate Trial, size 10	AR-623-109

### Size 1-10 Instrument Sets

Product Description	Item Number
CR Tibial Bearing Trial, size 1, 8 mm	AR-623-T108
CR Tibial Bearing Trial, size 2, 8 mm	AR-623-T208
CR Tibial Bearing Trial, size 3, 8 mm	AR-623-T308
CR Tibial Bearing Trial, size 4, 8 mm	AR-623-T408
CR Tibial Bearing Trial, size 5, 8 mm	AR-623-T508
CR Tibial Bearing Trial, size 6, 8 mm	AR-623-T608
CR Tibial Bearing Trial, size 7, 8 mm	AR-623-T708
CR Tibial Bearing Trial, size 8, 8 mm	AR-623-T808
CR Tibial Bearing Trial, size 9, 8 mm	AR-623-T908
CR Tibial Bearing Trial, size 10, 8 mm	AR-623-T1008
CR Tibial Bearing Trial, size 1, 9 mm	AR-623-T109
CR Tibial Bearing Trial, size 2, 9 mm	AR-623-T209
CR Tibial Bearing Trial, size 3, 9 mm	AR-623-T309
CR Tibial Bearing Trial, size 4, 9 mm	AR-623-T409
CR Tibial Bearing Trial, size 5, 9 mm	AR-623-T509
CR Tibial Bearing Trial, size 6, 9 mm	AR-623-T609
CR Tibial Bearing Trial, size 7, 9 mm	AR-623-T709
CR Tibial Bearing Trial, size 8, 9 mm	AR-623-T809
CR Tibial Bearing Trial, size 9, 9 mm	AR-623-T909
CR Tibial Bearing Trial, size 10, 9 mm	AR-623-T1009
CR Tibial Bearing Trial, size 1, 10 mm	AR-623-T110
CR Tibial Bearing Trial, size 2, 10 mm	AR-623-T210
CR Tibial Bearing Trial, size 3, 10 mm	AR-623-T310
CR Tibial Bearing Trial, size 4, 10 mm	AR-623-T410
CR Tibial Bearing Trial, size 5, 10 mm	AR-623-T510
CR Tibial Bearing Trial, size 6, 10 mm	AR-623-T610
CR Tibial Bearing Trial, size 7, 10 mm	AR-623-T710
CR Tibial Bearing Trial, size 8, 10 mm	AR-623-T810
CR Tibial Bearing Trial, size 9, 10 mm	AR-623-T910
CR Tibial Bearing Trial, size 10, 10 mm	AR-623-T1010
CR Tibial Bearing Trial, size 1, 11 mm	AR-623-T111
CR Tibial Bearing Trial, size 2, 11 mm	AR-623-T211
CR Tibial Bearing Trial, size 3, 11 mm	AR-623-T311
CR Tibial Bearing Trial, size 4, 11 mm	AR-623-T411
CR Tibial Bearing Trial, size 5, 11 mm	AR-623-T511
CR Tibial Bearing Trial, size 6, 11 mm	AR-623-T611
CR Tibial Bearing Trial, size 7, 11 mm	AR-623-T711
CR Tibial Bearing Trial, size 8, 11 mm	AR-623-T811
CR Tibial Bearing Trial, size 9, 11 mm	AR-623-T911
CR Tibial Bearing Trial, size 10, 11 mm	AR-623-T1011

Product Description	Item Number
CR Tibial Bearing Trial, size 1, 12 mm	AR-623-T112
CR Tibial Bearing Trial, size 2, 12 mm	AR-623-T212
CR Tibial Bearing Trial, size 3, 12 mm	AR-623-T312
CR Tibial Bearing Trial, size 4, 12 mm	AR-623-T412
CR Tibial Bearing Trial, size 5, 12 mm	AR-623-T512
CR Tibial Bearing Trial, size 6, 12 mm	AR-623-T612
CR Tibial Bearing Trial, size 7, 12 mm	AR-623-T712
CR Tibial Bearing Trial, size 8, 12 mm	AR-623-T812
CR Tibial Bearing Trial, size 9, 12 mm	AR-623-T912
CR Tibial Bearing Trial, size 10, 12 mm	AR-623-T1012
CR Tibial Bearing Trial, size 1, 13 mm	AR-623-T113
CR Tibial Bearing Trial, size 2, 13 mm	AR-623-T213
CR Tibial Bearing Trial, size 3, 13 mm	AR-623-T313
CR Tibial Bearing Trial, size 4, 13 mm	AR-623-T413
CR Tibial Bearing Trial, size 5, 13 mm	AR-623-T513
CR Tibial Bearing Trial, size 6, 13 mm	AR-623-T613
CR Tibial Bearing Trial, size 7, 13 mm	AR-623-T713
CR Tibial Bearing Trial, size 8, 13 mm	AR-623-T813
CR Tibial Bearing Trial, size 9, 13 mm	AR-623-T913
CR Tibial Bearing Trial, size 10, 13 mm	AR-623-T1013
Tibial Bearing Trial Attachment, 1 mm	AR-623-TS61
Tibial Bearing Trial Attachment, 2 mm	AR-623-TS62
Tibial Bearing Trial Attachment, 3 mm	AR-623-TS63
Tibial Bearing Trial Attachment, 4 mm	AR-623-TS64
Tibial Bearing Trial Attachment, 5 mm	AR-623-TS65
Tibial Bearing Trial Attachment, 6 mm	AR-623-TS66
Tibial Bearing Trial Attachment, 7 mm	AR-623-TS67
Tibial Bearing Trial Attachment, 8 mm	AR-623-TS68
Tibial Bearing Trial Attachment, 9 mm	AR-623-TS69
Tibial Bearing Trial Attachment, 10 mm	AR-623-TS610
Patella Trial, 30 mm	AR-603-79

### Miscellaneous Tray

Product Description	Item Number
Miscellaneous Instrument Tray	AR-613-M

## Spacer Block Instrument Set

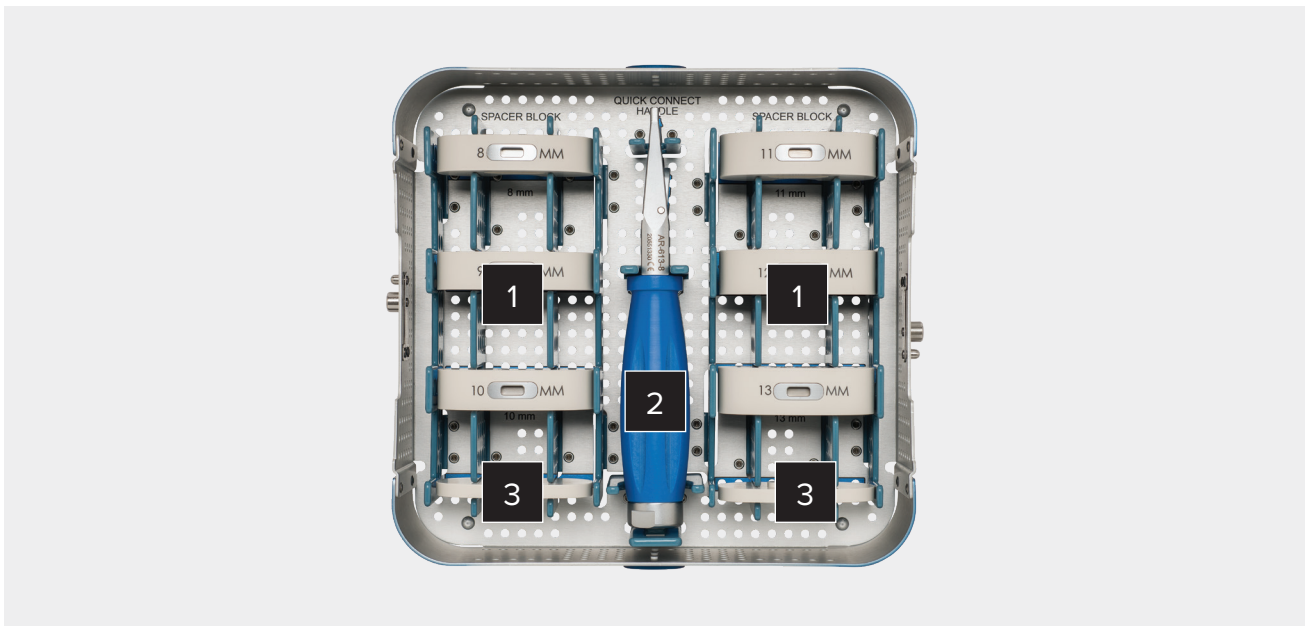

### Spacer Block Instrument Set - Spacer Block Tray (AR-613-C4)

Label	Product Description	Item Number
1	Spacer Block, 8 mm	AR-613-33
	Spacer Block, 9 mm	AR-613-34
	Spacer Block, 10 mm	AR-613-35
	Spacer Block, 11 mm	AR-613-36
	Spacer Block, 12 mm	AR-613-37
	Spacer Block, 13 mm	AR-613-38
	2	Quick-Connect Handle
3	Spacer Block Shim, 6 mm	AR-613-32

## Tibial Stem and Augment Instrument Set

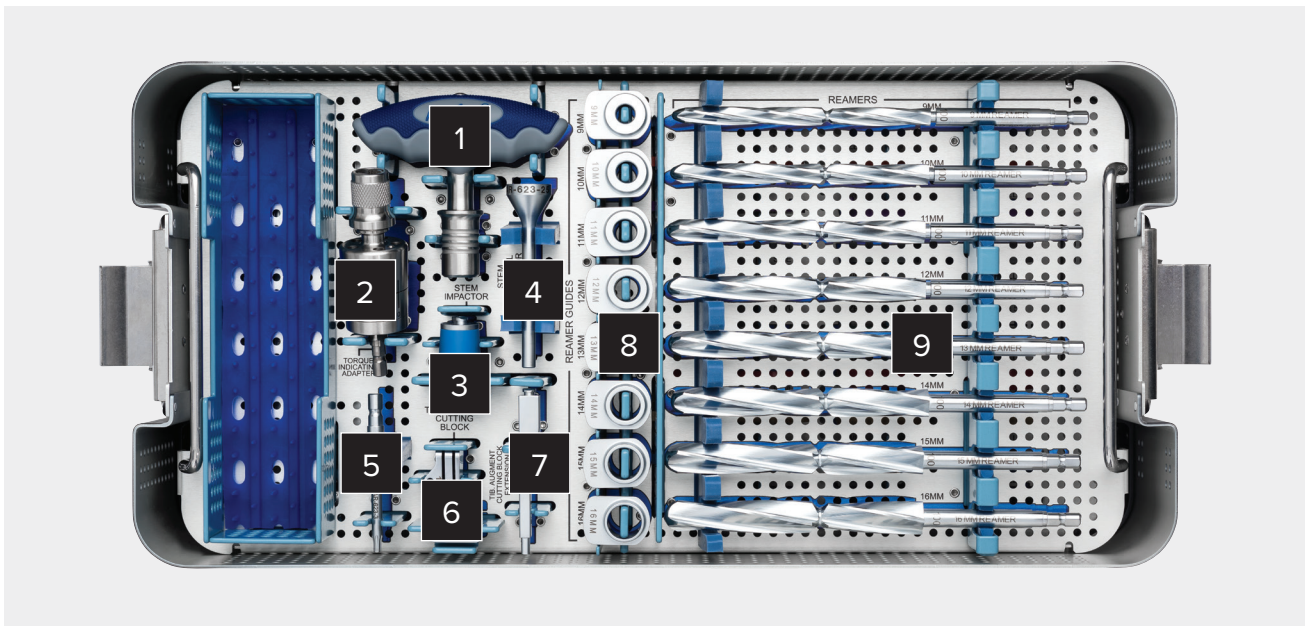

Tibial Stem and Augment Instrument Set, Top Tray (AR-623-S)

Label	Product Description	Item Number
1	T-handle	AR-623-27
2	Torque Indicating Adapter	AR-9545-T15H
3	Stem Impactor	AR-623-26
4	Stem Disassembly Impactor	AR-623-25
5	T20 Driver	AR-623-3
6	Augment Cutting Block	AR-623-2
7	Extension Arm	AR-623-1
8	Reamer Guide, 9 mm	AR-623-17
	Reamer Guide, 10 mm	AR-623-18
	Reamer Guide, 11 mm	AR-623-19
	Reamer Guide, 12 mm	AR-623-20
	Reamer Guide, 13 mm	AR-623-21
	Reamer Guide, 14 mm	AR-623-22
	Reamer Guide, 15 mm	AR-623-23
Reamer Guide, 16 mm	AR-623-24	
9	Reamer, size 9 mm	AR-623-09
	Reamer, size 10 mm	AR-623-10
	Reamer, size 11 mm	AR-623-11
	Reamer, size 12 mm	AR-623-12
	Reamer, size 13 mm	AR-623-13
	Reamer, size 14 mm	AR-623-14
	Reamer, size 15 mm	AR-623-15
Reamer, size 16 mm	AR-623-16	



## Tibial Stem and Augment Instrument Set (Cont.)

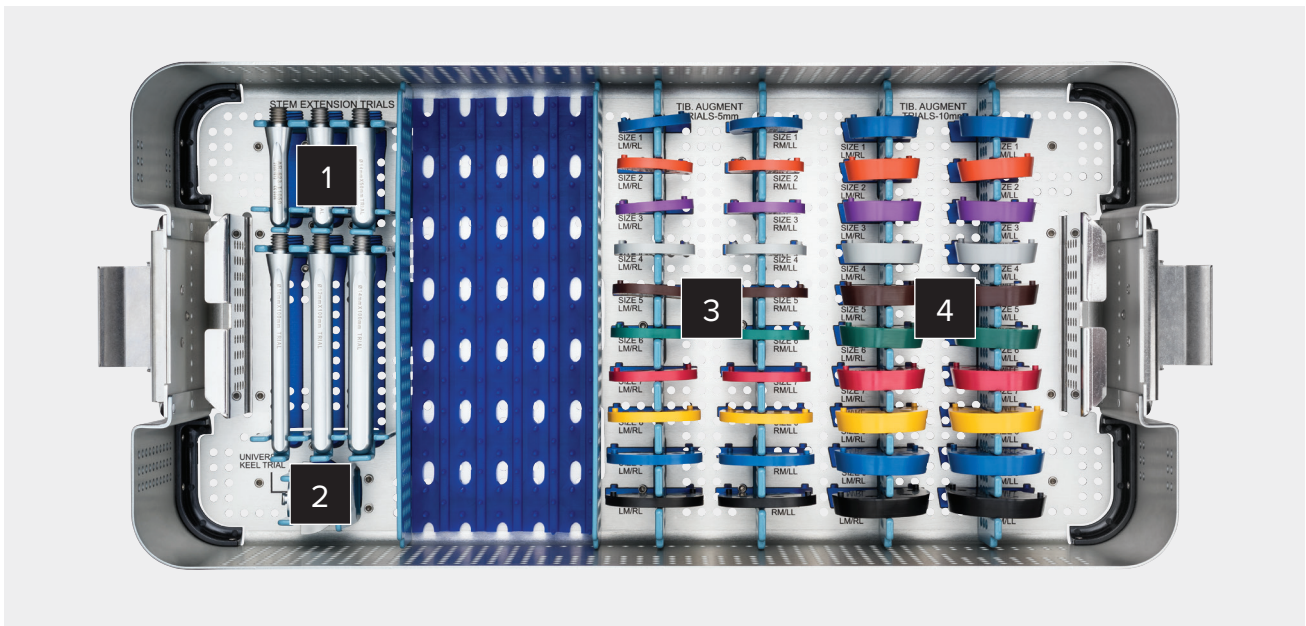

### Tibial Stem and Augment Instrument Set, Bottom Tray (AR-623-S)

Label	Product Description	Item Number
1	Stem Trial, 10 mm (D) × 50 mm (L)	AR-623-T1050
	Stem Trial, 10 mm (D) × 100 mm (L)	AR-623-T10100
	Stem Trial, 12 mm (D) × 50 mm (L)	AR-623-T1250
	Stem Trial, 12 mm (D) × 100 mm (L)	AR-623-T12100
	Stem Trial, 14 mm (D) × 50 mm (L)	AR-623-T1450
	Stem Trial, 14 mm (D) × 100 mm (L)	AR-623-T14100
2	Universal Keel, Stem Trials	AR-623-8
3	Tibial Augment Trial, RL, 5 mm, size 1	AR-623-RL15
	Tibial Augment Trial, RL, 5 mm, size 2	AR-623-RL25
	Tibial Augment Trial, RL, 5 mm, size 3	AR-623-RL35
	Tibial Augment Trial, RL, 5 mm, size 4	AR-623-RL45
	Tibial Augment Trial, RL, 5 mm, size 5	AR-623-RL55
	Tibial Augment Trial, RL, 5 mm, size 6	AR-623-RL65
	Tibial Augment Trial, RL, 5 mm, size 7	AR-623-RL75
	Tibial Augment Trial, RL, 5 mm, size 8	AR-623-RL85
	Tibial Augment Trial, RL, 5 mm, size 9	AR-623-RL95
	Tibial Augment Trial, RL, 5 mm, size 10	AR-623-RL105
	Tibial Augment Trial, RM, 5 mm, size 1	AR-623-RM15
	Tibial Augment Trial, RM, 5 mm, size 2	AR-623-RM25
	Tibial Augment Trial, RM, 5 mm, size 3	AR-623-RM35
	Tibial Augment Trial, RM, 5 mm, size 4	AR-623-RM45
	Tibial Augment Trial, RM, 5 mm, size 5	AR-623-RM55
	Tibial Augment Trial, RM, 5 mm, size 6	AR-623-RM65
	Tibial Augment Trial, RM, 5 mm, size 7	AR-623-RM75
	Tibial Augment Trial, RM, 5 mm, size 8	AR-623-RM85
	Tibial Augment Trial, RM, 5 mm, size 9	AR-623-RM9
	Tibial Augment Trial, RM, 5 mm, size 10	AR-623-RM105

Label	Product Description	Item Number
4	Tibial Augment Trial, RL, 10 mm, size 1	AR-623-RL110
	Tibial Augment Trial, RL, 10 mm, size 2	AR-623-RL210
	Tibial Augment Trial, RL, 10 mm, size 3	AR-623-RL310
	Tibial Augment Trial, RL, 10 mm, size 4	AR-623-RL410
	Tibial Augment Trial, RL, 10 mm, size 5	AR-623-RL510
	Tibial Augment Trial, RL, 10 mm, size 6	AR-623-RL610
	Tibial Augment Trial, RL, 10 mm, size 7	AR-623-RL710
	Tibial Augment Trial, RL, 10 mm, size 8	AR-623-RL810
	Tibial Augment Trial, RL, 10 mm, size 9	AR-623-RL910
	Tibial Augment Trial, RL, 10 mm, size 10	AR-623-RL1010
	Tibial Augment Trial, RM, 10 mm, size 1	AR-623-RM110
	Tibial Augment Trial, RM, 10 mm, size 2	AR-623-RM210
	Tibial Augment Trial, RM, 10 mm, size 3	AR-623-RM310
	Tibial Augment Trial, RM, 10 mm, size 4	AR-623-RM410
	Tibial Augment Trial, RM, 10 mm, size 5	AR-623-RM510
	Tibial Augment Trial, RM, 10 mm, size 6	AR-623-RM610
	Tibial Augment Trial, RM, 10 mm, size 7	AR-623-RM710
	Tibial Augment Trial, RM, 10 mm, size 8	AR-623-RM810
	Tibial Augment Trial, RM, 10 mm, size 9	AR-623-RM910
	Tibial Augment Trial, RM, 10 mm, size 10	AR-623-RM1010

## Ligament Balancing System Tray

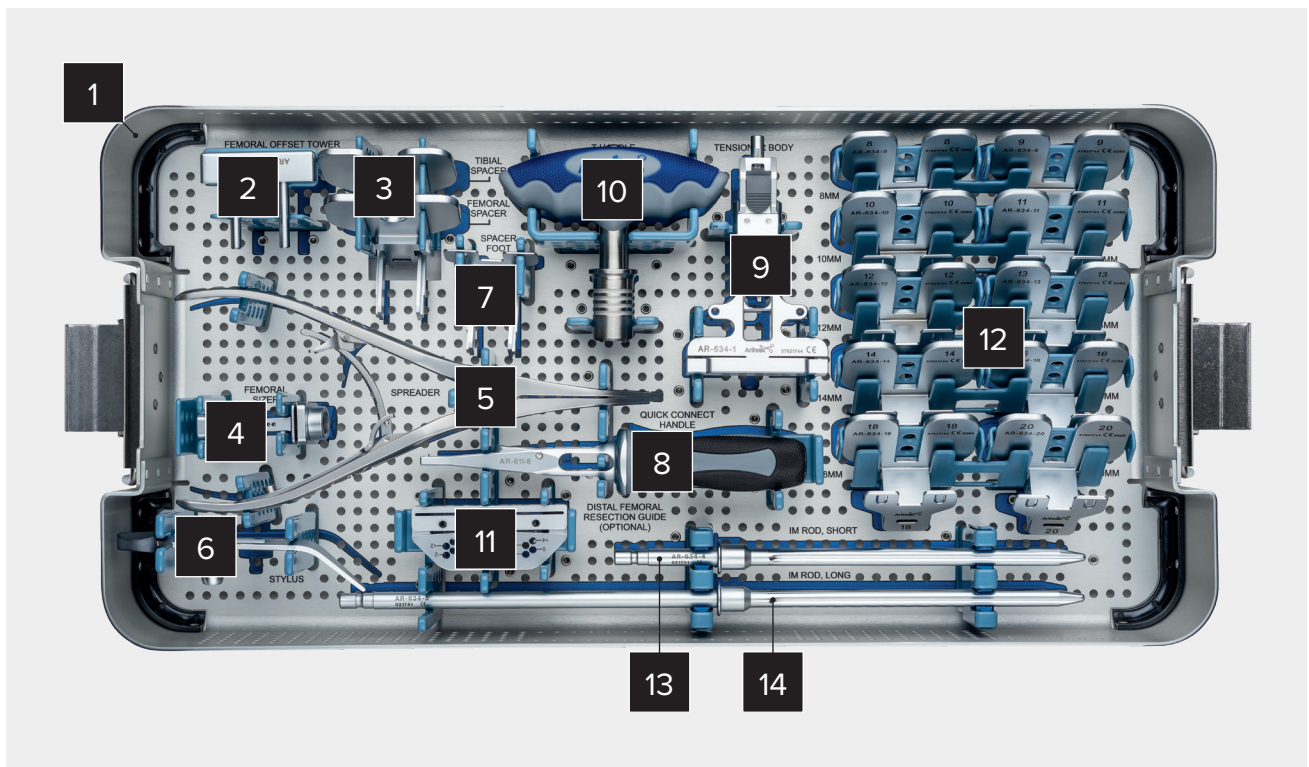

Ligament Balancing System Tray, Top Tray

Label	Product Description	Item Number
1	Ligament Balancing System, instrument case	AR-634-C
2	Offset Tower	AR-634-6
3	Adjustable Spacer Block, tibial spacer adjustable spacer block, femoral spacer	AR-634-30 AR-634-31
4	Sizer	AR-634-2
5	Spreader	AR-1340T
6	Stylus	AR-634-3
7	Adjustable Spacer Block, guide spacer	AR-634-32
8	Quick Connect	AR-623-27
9	Tensioner Body	AR-634-1
10	T-handle	AR-611-8
11	Adjustable Distal Femoral Cutting Guide	AR-634-7
12	Spacer, 8 mm Spacer, 9 mm Spacer, 10 mm Spacer, 11 mm Spacer, 12 mm Spacer, 13 mm Spacer, 14 mm Spacer, 16 mm Spacer, 18 mm Spacer, 20 mm	AR-634-8 AR-634-9 AR-634-10 AR-634-11 AR-634-12 AR-634-13 AR-634-14 AR-634-16 AR-634-18 AR-634-20
13	Collared IM Rod, short	AR-634-4
14	Collared IM Rod, long	AR-634-5

## References

---

1. Magosch P, Lichtenberg S, Habermeyer P. Survival of stemless humeral head replacement in anatomic shoulder arthroplasty: a prospective study. *J Shoulder Elbow Surg.* 2021;30(7):e343-e355. doi:10.1016/j.jse.2020.09.034
2. Alikhah A, Imiolczyk J, Krukenberg A, Scheibel M. Screw fixation in stemless shoulder arthroplasty for the treatment of primary osteoarthritis leads to less osteolysis when compared to impaction fixation. *BMC Musculoskelet Disord.* 2020;21(1):295. doi:10.1186/s12891-020-03277-3
3. Sites Medical Research and Development. Bone ingrowth performance of OsteoSync™ Ti. Available at: <https://www.sitesmedical.com/wp-content/uploads/The-Bone-Ingrowth-Performance-of-OsteoSync-Ti.pdf>
4. Erickson BJ, Shishani Y, Bishop ME, Romeo AA, Lederman E, Gobeze R. Tuberosity repair in reverse total shoulder arthroplasty for fracture using a stem-based double-row repair: a cadaveric biomechanical study. *J Am Acad Orthop Surg.* 2020;28(23):e1059-1065. doi:10.5435/JAAOS-D-19-0066
5. Arthrex, Inc. Data on file (LA0239). Naples, FL; 2008.
6. Schmalzl J, Jessen M, Holschen M, et al. Tuberosity healing improves functional outcome following primary reverse shoulder arthroplasty for proximal humeral fractures with a 135° prosthesis. *Eur J Orthop Surg Traumatol.* 2020;30(5):909-916. Dot:10.1007/s00590-020-02649-8
7. Arthrex, Inc. Data on file (MyVIP pilot study). Naples, FL; 2021.
8. Traynor A, Simpson D, Collins S. ECiMa™ for low wear, optimal mechanical properties and oxidation resistance of hip bearings. In: Knahr K. *Total Hip Arthroplasty: Wear Behavior of Different Articulations.* Springer; 2012:169-181.
9. Oral E, Wannomae KK, Hawkins N, Harris WH, Muratoglu OK. Alpha-tocopherol-doped irradiated UHMWPE for high fatigue resistance and low wear. *Biomaterials.* 2004;25(24):5515-5522. doi:10.1016/j.biomaterials.2003.12.048
10. Oral E, Christensen SD, Malhi AS, Wannomae KK, Muratoglu OK. Wear resistance and mechanical properties of highly cross-linked, ultrahigh-molecular weight polyethylene doped with vitamin E. *J Arthroplasty.* 2006;21(4):580-591. doi:10.1016/j.arth.2005.07.009



This description of technique is provided as an educational tool and clinical aid to assist properly licensed medical professionals in the usage of specific Arthrex products. As part of this professional usage, the medical professional must use their professional judgment in making any final determinations in product usage and technique. In doing so, the medical professional should rely on their own training and experience and should conduct a thorough review of pertinent medical literature and the product's directions for use. Postoperative management is patient-specific and dependent on the treating professional's assessment. Individual results will vary and not all patients will experience the same postoperative activity level or outcomes.

**[arthrex.com](https://arthrex.com)**

© 2024-03 Arthrex, Inc. All rights reserved. LB1-000312-en-US\_C



Arthrex manufacturer,  
authorized representative,  
and importer information  
(Arthrex eIFUs)



US patent information

